







Magnetic Linear System 2.0



# Antwerp

Magnetic Linear System 2.0

Profile		Recessed	Surface-mounted	Pendant	
					
		CXL35	CXL35M	CXL35M	
LED Module	Options	Linear Flood Module 	Linear Spot Module 	Track Spot Module 	Pendant Spot Module 
		CXL35B03 CXL35B06 CXL35B09	CXL35S03 CXL35S06	CXL35L	CXL35D
	LED				
		SMD2835	SMD3030	COB	COB
	CRI & CCT	927 930 940	927 930 940	927 930 940	927 930 940
	Beam	110°	12°/34°/48°	12°/24°/36°	12°/24°/36°
Wattage & Luminous Flux	7W / 410~600lm 14W / 840~1100lm 21W / 1200~1400lm	21W / 1100~1400lm 42W / 2300~2700lm	3W / 250~300lm 5W / 350~420lm 7W / 460~580lm	3W / 300~350lm 5W / 360~450lm 7W / 460~610lm	
Power Supply	Constant Voltage Driver				
		CVD/80/24 80W 220-240V 3.3A DC24V 195*51*40mm	CVD/150/24 150W 220-240V 6.25A DC24V 224*69*40mm		

## Feature:

- LED magnetic linear system is a combination system of aluminum extrusion profile with recessed, surface-mounted, pendant options, different functional LED modules, drivers and different accessories.
- The profile can be cut and connected, to achieve different aesthetic shapes and linear lighting effect, as per the specific room size.

## Installation Diagram( Recessed)

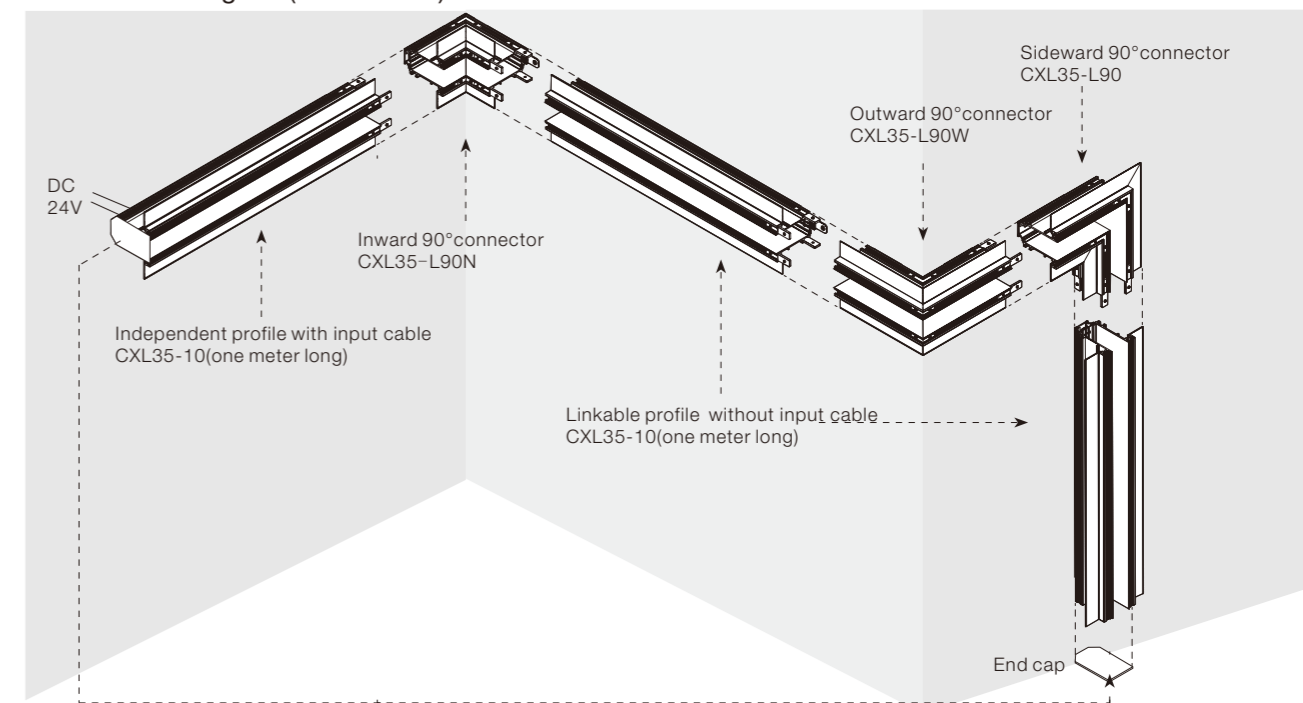



**Recessed Profile (to be ordered separately)**  
Model: CXL35-10  
Material: Extruded aluminum  
Finish: Black  
Input Voltage: 24V DC  
Remarks:  
The linear profile comes with a standard length of 1 meter, including profile with input cable and profile without input cable, two options

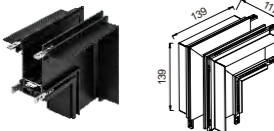

**Outward 90°connector (to be ordered separately)**  
Model: CXL35-L90W  
Material: Extruded aluminum  
Finish: Black  
Input Voltage: 24V DC  
Remarks:  
Suitable for cornering on different planes, e.g the cornering from wall to wall



**Sideward 90°connector (to be ordered separately)**  
Model: CXL35-L90  
Material: Extruded aluminum  
Finish: Black  
Input Voltage: 24V DC  
Remarks:  
Suitable for cornering on the same plane



**Inward 90°connector (to be ordered separately)**  
Model: CXL35-L90N  
Material: Extruded aluminum  
Finish: Black  
Input Voltage: 24V DC  
Remarks:  
Suitable for cornering on different planes, e.g the corner from ceiling to wall



**"1" Shape Straight Connector (to be ordered separately)**  
Model: CXL35-IJ  
Material: Extruded aluminum  
Finish: Black  
Input Voltage: 24V DC  
Remarks: to connect two profiles and conduct electricity, once profile is cut, at site.



**DC 24V constant voltage LED driver (to be ordered separately)**  
Model: CVD/80/24  
Wattage: 80W  
Input Voltage: 220-240V  
Output Current: 3.3A  
Output Voltage: DC24V  
Dimension: 195\*51\*40mm  
  
Model: CVD/150/24  
Wattage: 150W  
Input Voltage: 220-240V  
Output Current: 6.25A  
Output Voltage: DC24V  
Dimension: 224\*69\*40mm

Installation Diagram(Surface mounted)

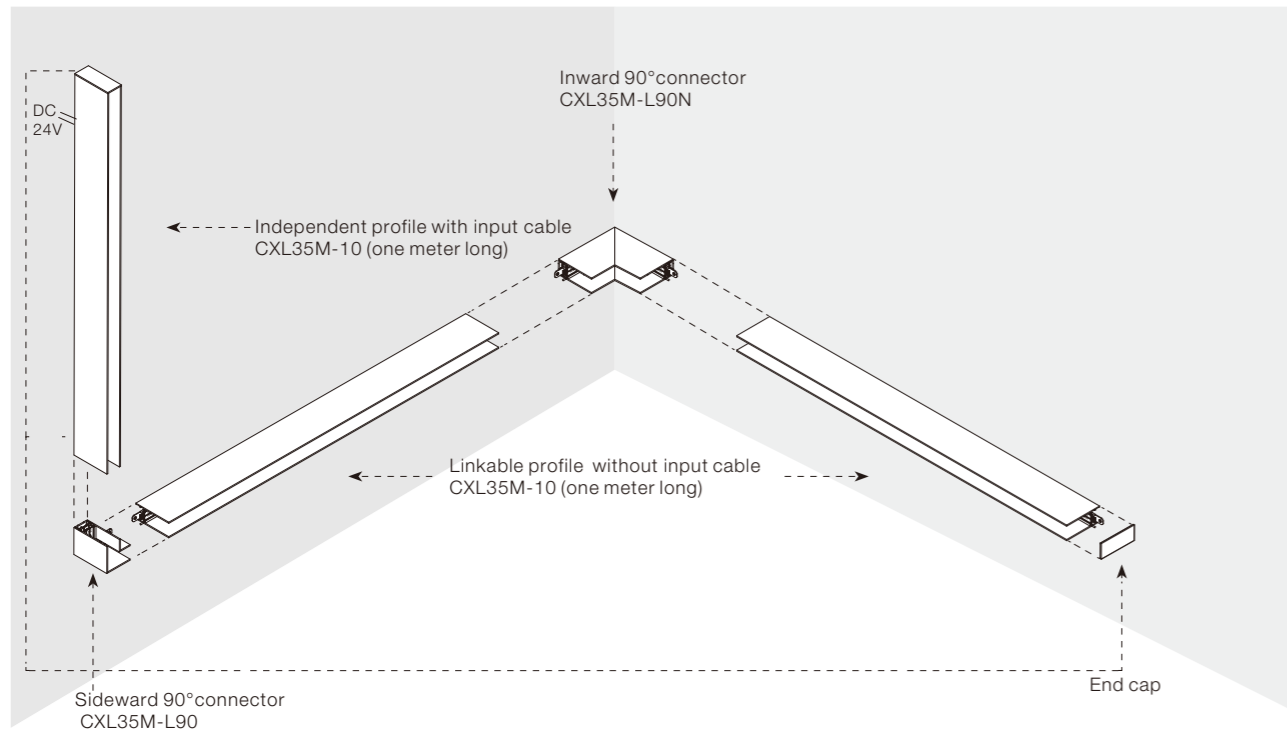

Installation Diagram(Pendant)

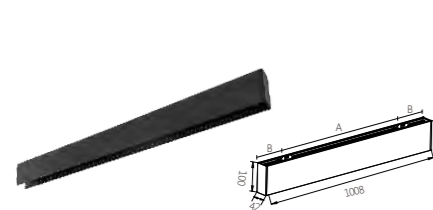
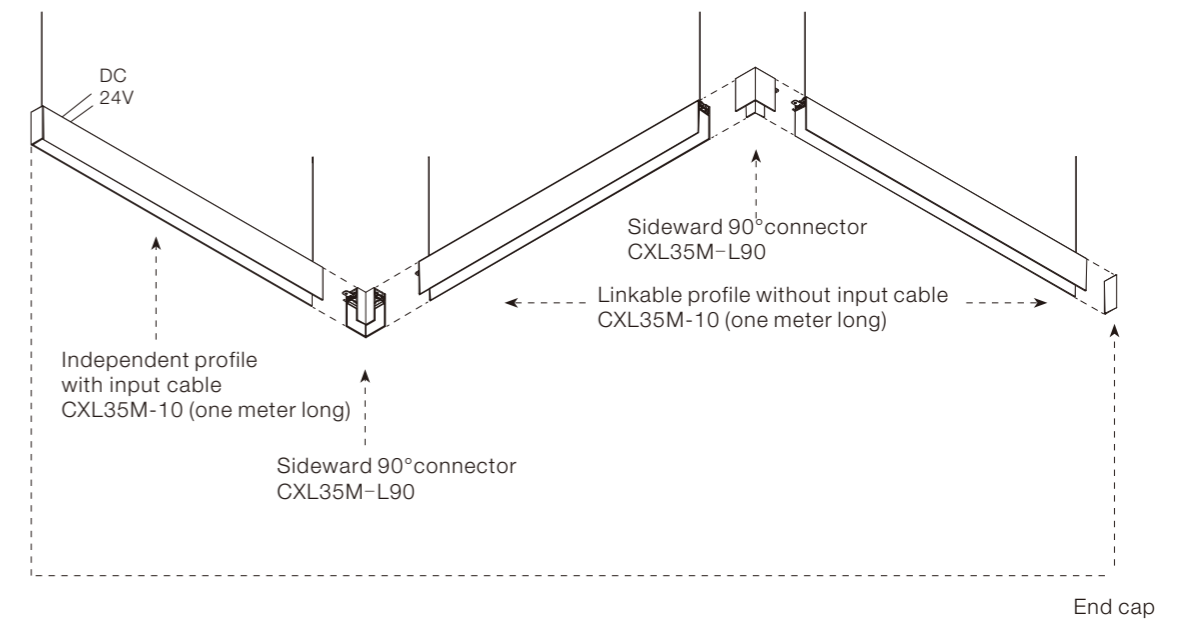

**Profile for surface or pendant mounted (to be ordered separately)**

Model: CXL35M-10  
Material: Extruded aluminum  
Finish: Black  
Input Voltage: 24V DC  
Remarks:  
The linear profile comes with a standard length of 1 meter, including profile with input cable and profile without input cable, two options

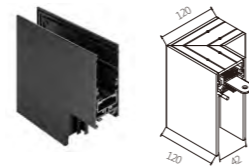

**Outward 90°connector (to be ordered separately)**

Model: CXL35M-L90W  
Material: Extruded aluminum  
Finish: Black  
Input Voltage: 24V DC  
Remarks:  
Suitable for cornering on different planes, e.g the cornering from wall to wall



**Profile for surface or pendant mounted (to be ordered separately)**

Model: CXL35M-10  
Material: Extruded aluminum  
Finish: Black  
Input Voltage: 24V DC  
Remarks:  
The linear profile comes with a standard length of 1 meter, including profile with input cable and profile without input cable, two options

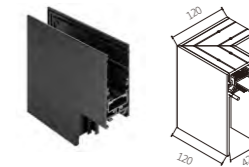

**Outward 90°connector (to be ordered separately)**

Model: CXL35M-L90W  
Material: Extruded aluminum  
Finish: Black  
Input Voltage: 24V DC  
Remarks:  
Suitable for cornering on different planes, e.g the cornering from wall to wall

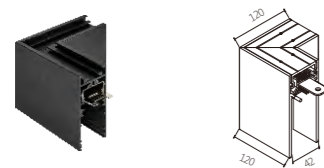

**Sideward 90°connector (to be ordered separately)**

Model: CXL35M-L90  
Material: Extruded aluminum  
Finish: Black  
Input Voltage: 24V DC  
Remarks:  
Suitable for cornering on the same plane



**1" Shape Straight Connector (to be ordered separately)**

Model: CXL35-IJ  
Material: Extruded aluminum  
Finish: Black  
Input Voltage: 24V DC  
Remarks: to connect two profiles and conduct electricity,once profile is cut, at site.

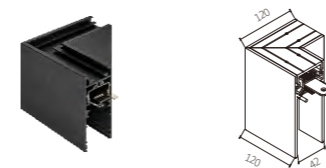

**Sideward 90°connector (to be ordered separately)**

Model: CXL35M-L90  
Material: Extruded aluminum  
Finish: Black  
Input Voltage: 24V DC  
Remarks:  
Suitable for cornering on the same plane



**1" Shape Straight Connector (to be ordered separately)**

Model: CXL35-IJ  
Material: Extruded aluminum  
Finish: Black  
Input Voltage: 24V DC  
Remarks: to connect two profiles and conduct electricity,once profile is cut, at site.

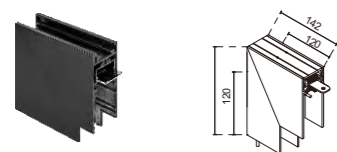

**Inward 90°connector (to be ordered separately)**

Model: CXL35M-L90N  
Material: Extruded aluminum  
Finish: Black  
Input Voltage: 24V DC  
Remarks:  
Suitable for cornering on different planes, e.g the corner from ceiling to wall



**DC 24V constant voltage LED driver (to be ordered separately)**

Model: CVD/80/24  
Wattage: 80W  
Input Voltage: 220-240V  
Output Current: 3.3A  
Output Voltage: DC24V  
Dimension: 195\*51\*40mm

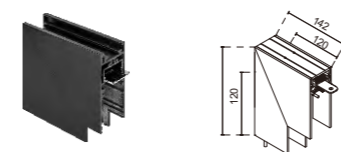

**Inward 90°connector (to be ordered separately)**

Model: CXL35M-L90N  
Material: Extruded aluminum  
Finish: Black  
Input Voltage: 24V DC  
Remarks:  
Suitable for cornering on different planes, e.g the corner from ceiling to wall



**DC 24V constant voltage LED driver (to be ordered separately)**

Model: CVD/80/24  
Wattage: 80W  
Input Voltage: 220-240V  
Output Current: 3.3A  
Output Voltage: DC24V  
Dimension: 195\*51\*40mm



**Accessories kit for surface-mounted (to be ordered separately)**

Model: CXL35M-XDB



**Accessories kit for pendant-mounted (to be ordered separately)**

Model: CXL35M-DXB

### Custom Cut Available

The magnetic linear system is more flexible, more integrated with ceiling. And, length, circuit can be allocated, according to the site situation.

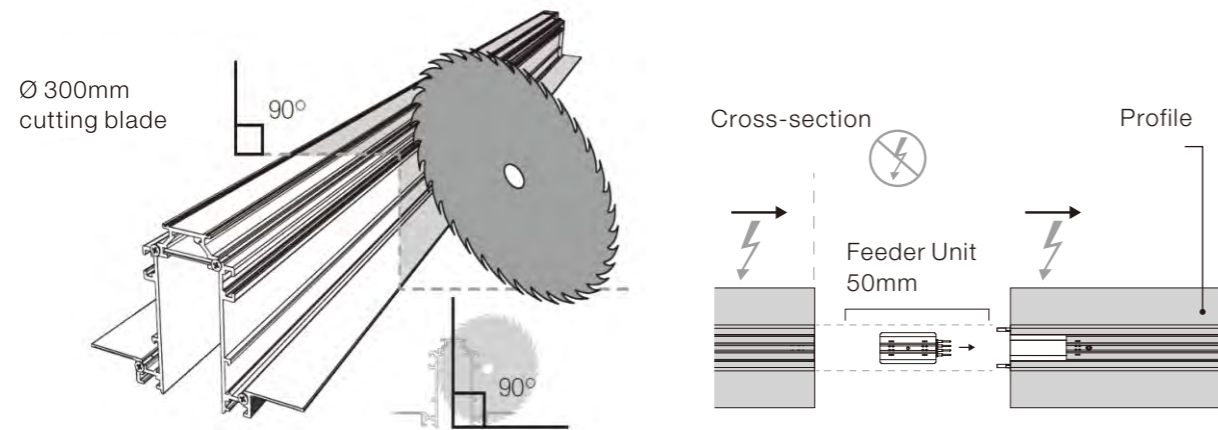

#### Remarks:

1. There will be deviation between the site situation, which may result in that the length of recessed profile is not 100% compatible.
2. The qualified professional can cut the profile to meet the requested length at site, if the construction condition is available.
3. Aluminum alloy cutting blade is suggested to be used and the diameter of cutting blade should not less than 300 mm.

#### Subdivision control in the same linear lighting system

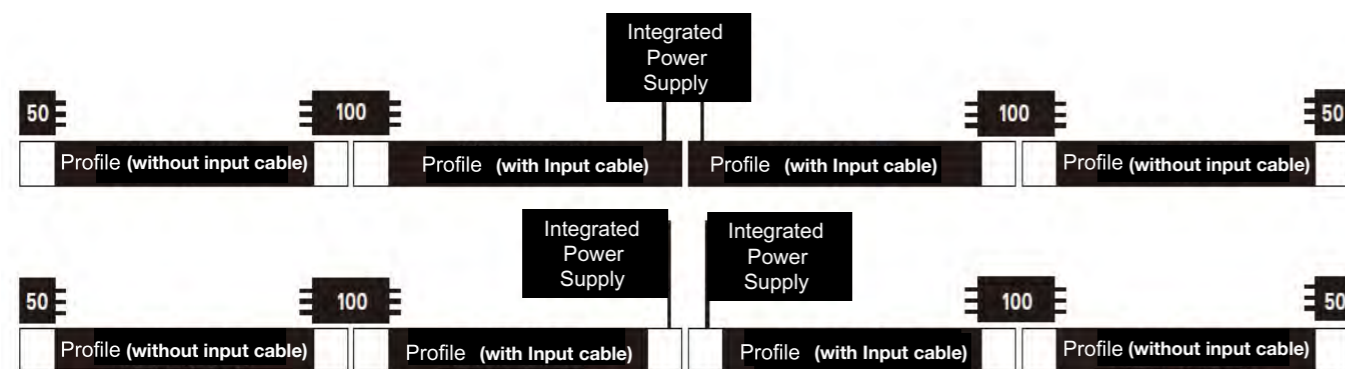

#### Suggestion of lighting modules installation:

1. Magnetic linear system for accent lighting can satisfy the lighting combination of different modules, but we do not suggest putting too many modules into one profile.
2. If subdivision control is needed in the same linear system, the above diagram is a typical example for your reference.
3. We suggest to use LED driver(s) which rated power output is at least 10% higher than the total power consumption in the linear system.

### “I” shape magnetic connector

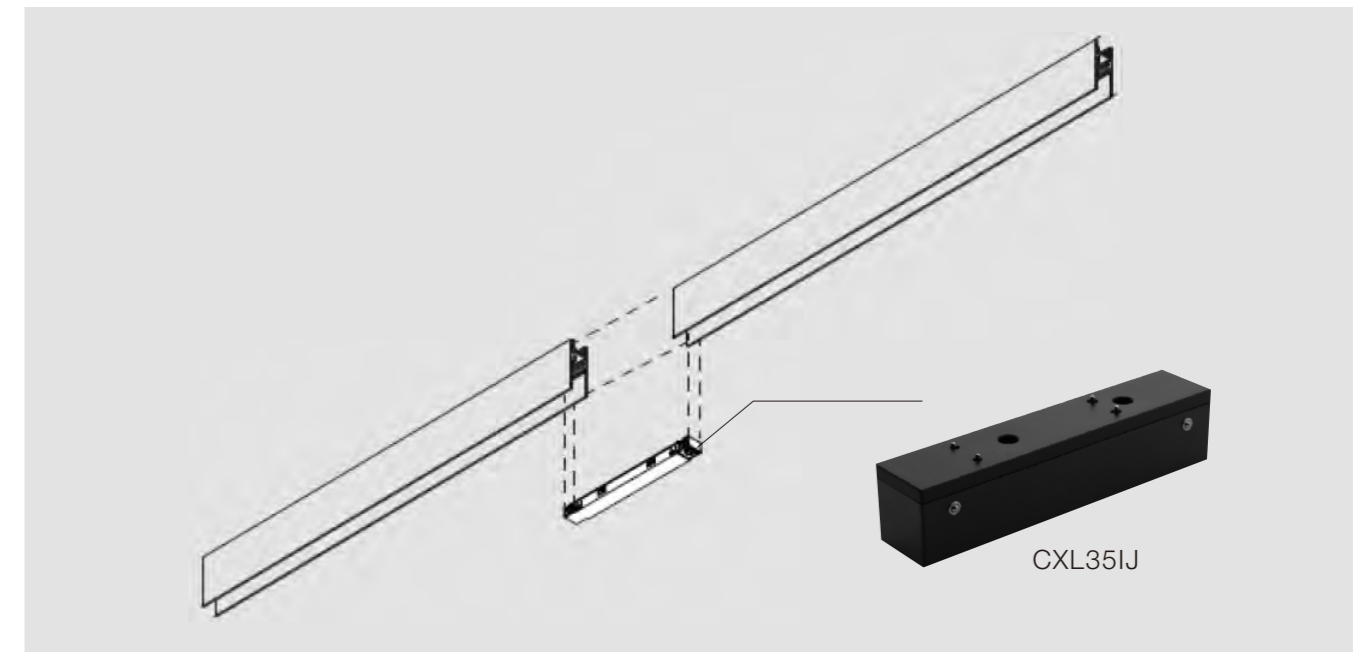

“I” shape magnetic connector, for easy connection between each two profiles.

### Two kinds of profiles

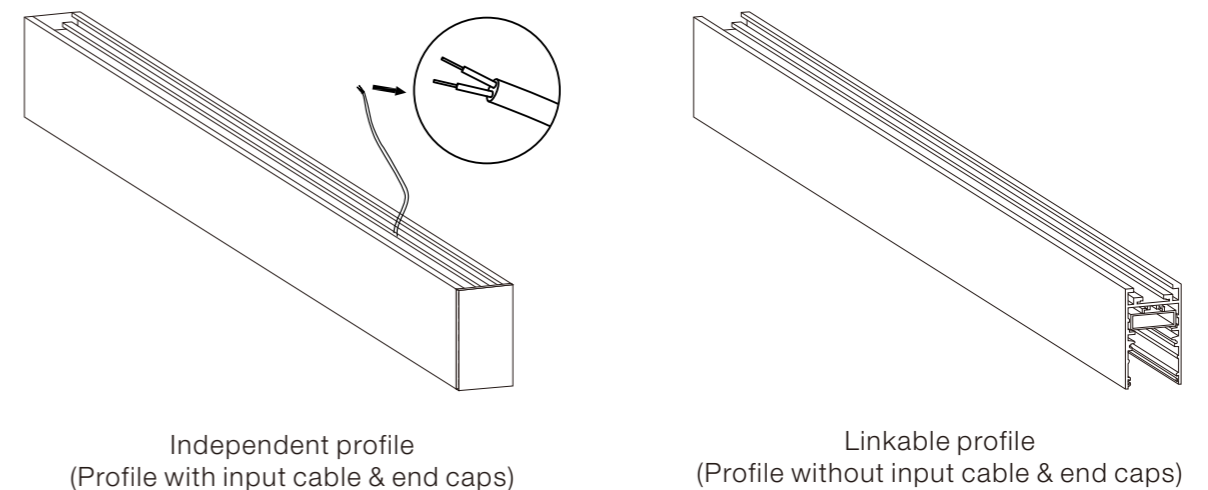

## Antwerp



### CXL35-10/CXL35-20

- Cut-out** : 65mm(width)
- Input Voltage** : DC 24V
- Dimension** : W117xH90mm
- Length** : 1000mm / 2000mm
- Finish** : Matte black
- Material** : Extruded aluminum
- Remarks** : Linear track only, excluding driver or LED module

Normal ordering length is 1m or 2m

Recessed

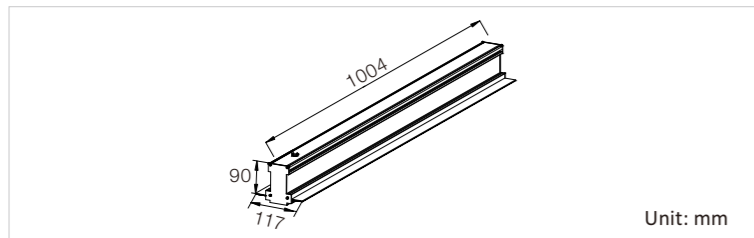

#### Accessories for connection( to be ordered separately)

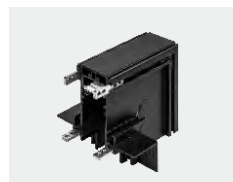

Inward 90°connector  
CXL35-L90N

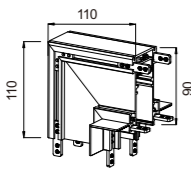

Outward 90°connector  
CXL35-L90W

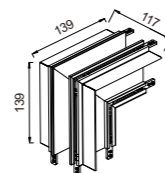

Sideward 90°connector  
CXL35-L90

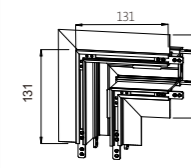

"I" shape  
magnetic connector  
CXL35IJ

#### Driver ( to be ordered separately)



**CVD/80/24**  
DC24V  
80W



**CVD/150/24**  
DC24V  
150W

### ORDERING INFORMATION:

Example: CXL35/10/Y/A/LF/L90

Model	Length	Connection type or not	Installation	Module options	Accessories for connection
CXL35	10	Y	A	LF	L90
CXL35	10 1000mm 20 2000mm	Y Connection type N Non-connection type	A Recessed	LF Linear Flood Module LS Linear Spot Module TS Track Spot Module PS Pendant Spot Module	L90 Sideward 90°connector L90N Inward 90°connector L90W Outward 90°connector IJ "I" shape connector

## Antwerp



### CXL35M-10 / CXL35M-20

- Input Voltage** : DC 24V
- Dimension** : W42xH100mm
- Length** : 1000mm / 2000mm
- Finish** : Matte black
- Material** : Extruded aluminum
- Remarks** : Linear track only, excluding driver or LED module

Normal ordering length is 1m or 2m

Surface mounted

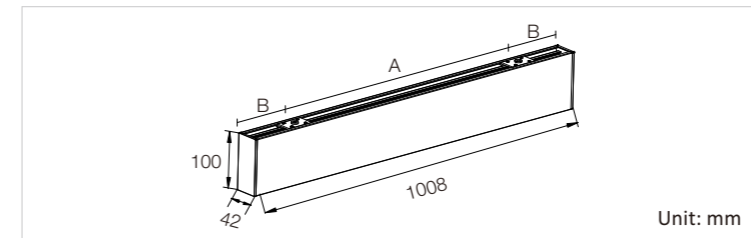

#### Accessories for connection( to be ordered separately)



Inward 90°connector  
CXL35M-L90N

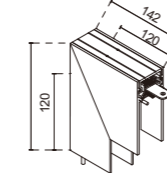

Outward 90°connector  
CXL35M-L90W

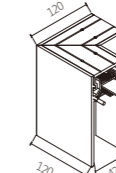

Sideward 90°connector  
CXL35M-L90

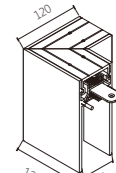

Surface-mounted kit  
CXL35M-XDB



"I" shape  
magnetic connector  
CXL35IJ

#### Driver ( to be ordered separately)



**CVD/80/24**  
DC24V  
80W



**CVD/150/24**  
DC24V  
150W

### ORDERING INFORMATION:

Example: CXL35M/10/Y/B/LF/L90

Model	Length	Connection type or not	Installation	Module options	Accessories for connection
CXL35M	10	Y	B	LF	L90
CXL35M	10 1000mm 20 2000mm	Y Connection type N Non-connection type	B Surface-mounted	LF Linear Flood Module LS Linear Spot Module TS Track Spot Module PS Pendant Spot Module	L90 Sideward 90°connector L90N Inward 90°connector L90W Outward 90°connector SK Surface-mounted kit IJ "I" shape connector

## Antwerp



### CXL35M-10 / CXL35M-20

- Input Voltage :** DC 24V
- Dimension :** W42xH100mm
- Length :** 1000mm / 2000mm
- Finish :** Matte black
- Material :** Extruded aluminum
- Remarks :** Linear track only, excluding driver or LED module

Normal ordering length is 1m or 2m

### Pendant

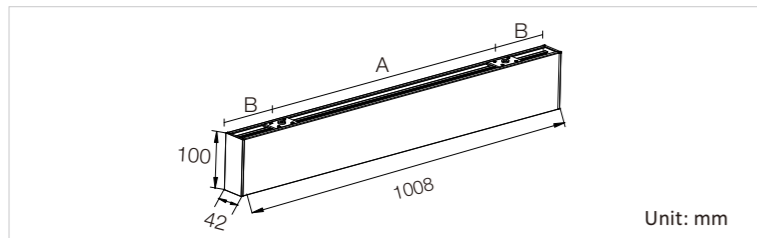

### Accessories for connection (to be ordered separately)



Inward 90°connector  
CXL35M-L90N

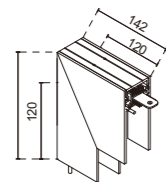

Outward 90°connector  
CXL35M-L90W



Sideward 90°connector  
CXL35M-L90

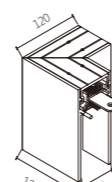
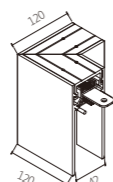

### Driver (to be ordered separately)

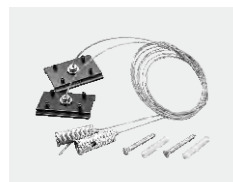

Pendant kit  
CXL35M-DXB



"I" shape  
magnetic connector  
CXL35IJ



**CVD/80/24**  
DC24V  
80W



**CVD/150/24**  
DC24V  
150W

## ORDERING INFORMATION:

Example: CXL35M/10/Y/C/LF/L90

Model	Length	Connection type or not	Installation	Module options	Accessories for connection
<b>CXL35M</b>	<b>10</b>	<b>Y</b>	<b>C</b>	<b>LF</b>	<b>L90</b>
CXL35M	10 1000mm 20 2000mm	Y Connection type N Non-connection type	C Pendant	LF Linear Flood Module LS Linear Spot Module TS Track Spot Module PS Pendant Spot Module	L90 Sideward 90°connector L90N Inward 90°connector L90W Outward 90°connector PK Pendant kit IJ "I" shape connector

## Antwerp



### CXL35B

- Wattage :** 7W/14W/21W
- CRI :** Ra ≥ 90
- CCT :** 2700K/3000K/4000K
- Beam :** 110°
- Finish :** Black body and white diffuser
- Material :** Extruded aluminum body and PC diffuser
- Remarks :** LED module only, excluding driver or linear track; there is no driver in this module, but a built-in convertor in the box to convert constant voltage to constant current.

### Linear Flood Module

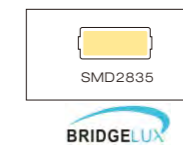
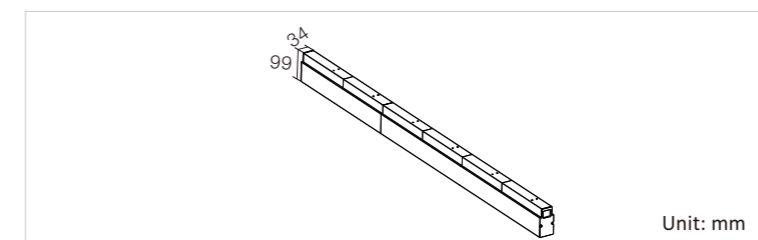

### All models of linear flood module

Model	CXL35B03	CXL35B06	CXL35B09
Wattage	7W	14W	21W
Lumen	410~600lm	840~1100lm	1200~1400lm
Length	300mm	600mm	900mm

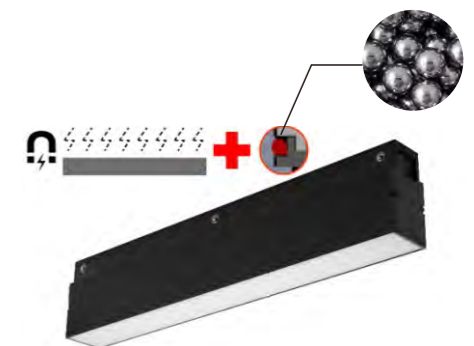

Ball catch design, more safe

CXL35B03

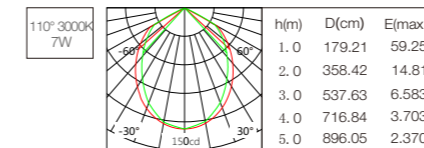

CXL35B06

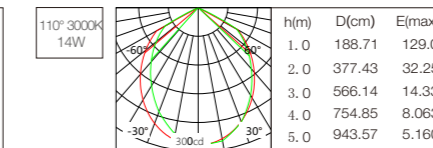

CXL35B09

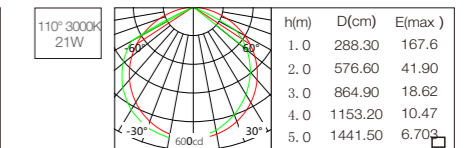

## ORDERING INFORMATION: LED module only.

Example: CXL35B/03/7W/927

Model	Length	Wattage	CRI & CCT
<b>CXL35B</b>	<b>03</b>	<b>7W</b>	<b>927</b>
CXL35B	03 300mm 06 600mm 09 900mm	7W 14W 21W	927 Ra ≥ 90 2700K 930 Ra ≥ 90 3000K 940 Ra ≥ 90 4000K

## Antwerp



### CXL35S

- Wattage** : 21W / 42W
- CRI** : Ra ≥ 90
- CCT** : 2700K / 3000K / 4000K
- Beam** : 12° / 34° / 48°
- Finish** : Black body and louvers, mirror reflector
- Material** : Extruded aluminum body, PC louvers and reflector
- Remarks** : LED module only, excluding driver or linear track; there is no driver in this module, but a built-in convertor in the box to convert constant voltage to constant current.

Linear Spot Module

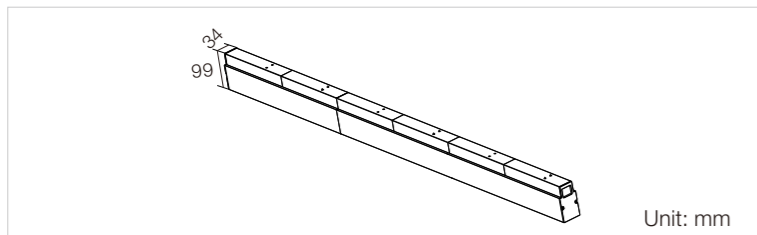

All models of linear spot module

Model	CXL35S03	CXL35S06
Wattage	21W	42W
Lumen	1100~1400lm	2300~2700lm
Length	322mm	640mm

CXL35S03

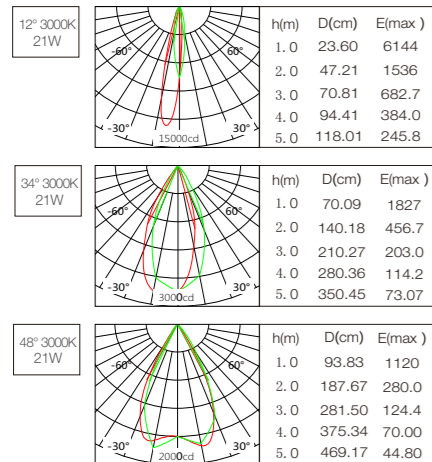

CXL35S06

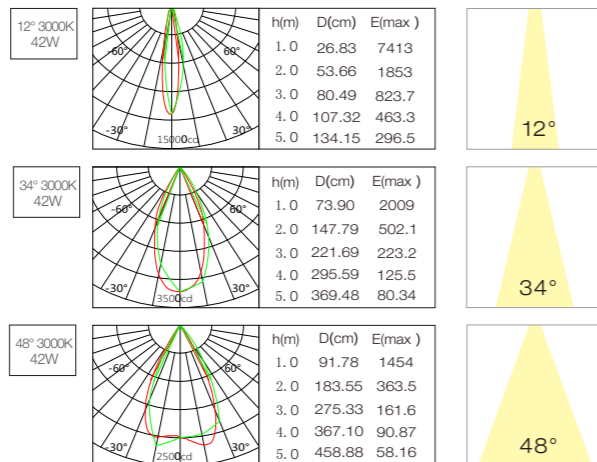

### ORDERING INFORMATION:

Example: CXL35S/03/21W/927/12D

Model	Length	Wattage	CRI & CCT	Beam
CXL35S	03	21W	927	12D
CXL35S	06	42W	927 Ra ≥ 90 2700K 930 Ra ≥ 90 3000K 940 Ra ≥ 90 4000K	12D 12° 34D 34° 48D 48°

## Antwerp



### CXL35L

- Wattage** : 3W / 5W / 7W
- CRI** : Ra ≥ 90
- CCT** : 2700K / 3000K / 4000K
- Beam** : 12° / 24° / 36°
- Lumen** : 250~300lm(3W) / 350~420lm(5W) / 460~580lm(7W)
- Finish** : Black body and clear lens
- Material** : Extruded aluminum heatsink, aluminum ring and PC lens
- Remarks** : LED module only, excluding driver or linear track; there is no driver in this module, but a built-in convertor in the box to convert constant voltage to constant current.

Track Spot Module

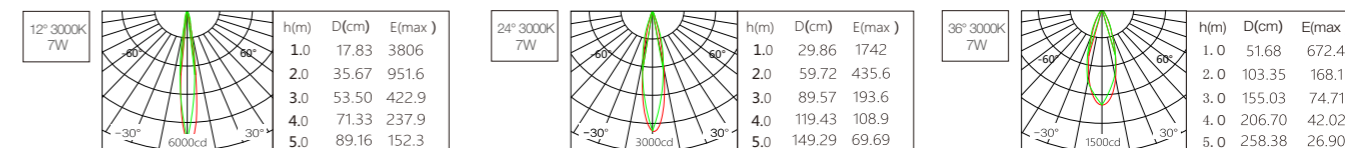
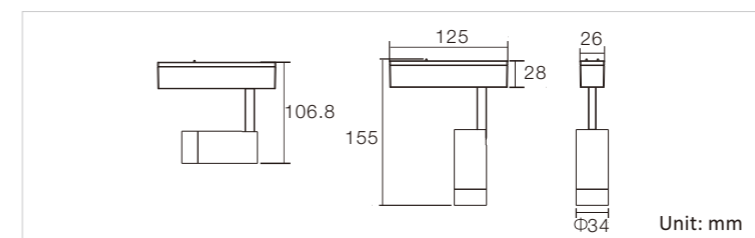

### ORDERING INFORMATION: LED module only.

Example: CXL35L/3W/927/12D

Model	Wattage	CRI & CCT	Beam
CXL35L	3W	927	12D
CXL35L	5W	927 Ra ≥ 90 2700K 930 Ra ≥ 90 3000K 940 Ra ≥ 90 4000K	12D 12° 24D 24° 36D 36°

Antwerp



**CXL35L**

- Wattage** : 30W
- CRI** : Ra ≥ 80
- CCT** : 2700K / 3000K / 4000K
- Beam** : 15° / 24° / 36°
- Lumen** : 2300lm
- Finish** : Black body and clear lens
- Material** : Extruded aluminum heatsink, aluminum ring and honeycomb louver
- Remarks** : LED module only, excluding driver or linear track; there is no driver in this module, but a built-in convertor in the box to convert constant voltage to constant current.

Track Spot Module

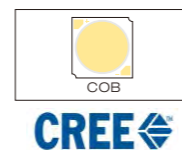
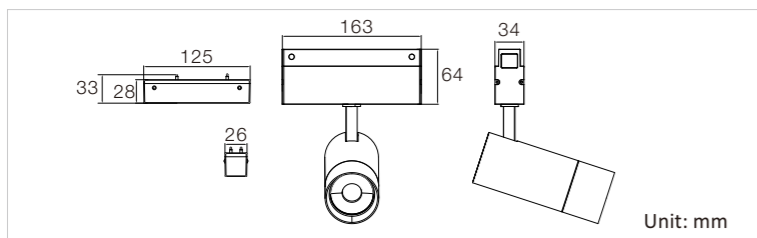

Antwerp



**CXL35D**

- Wattage** : 3W / 5W / 7W
- CRI** : Ra ≥ 90
- CCT** : 2700K / 3000K / 4000K
- Beam** : 12° / 24° / 36°
- Lumen** : 300~350lm(3W) / 360~450lm(5W) / 460~610lm(7W)
- Finish** : Black body and clear lens
- Material** : Extruded aluminum heatsink, aluminum ring and PC lens
- Remarks** : LED module only, excluding driver or linear track; there is no driver in this module, but a built-in convertor in the box to convert constant voltage to constant current.

Pendant Spot Module

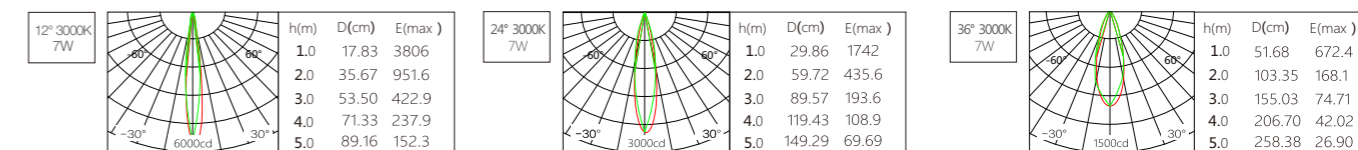
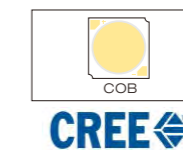
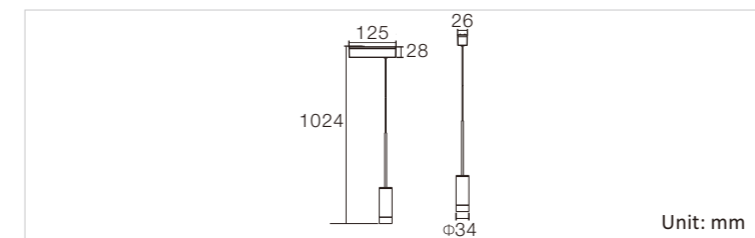

**ORDERING INFORMATION:** LED module only.

Example: CXL35L/30W/927/15D

Model	Wattage	CRI & CCT	Beam
CXL35L	30W	927	15D
CXL35L	30W	927 Ra ≥ 90 2700K	15D 15°
		930 Ra ≥ 90 3000K	24D 24°
		940 Ra ≥ 90 4000K	36D 36°

**ORDERING INFORMATION:** LED module only.

Example: CXL35D/3W/927/12D

Model	Wattage	CRI & CCT	Beam
CXL35D	3W	927	12D
CXL35D	3W	927 Ra ≥ 90 2700K	12D 12°
	5W	930 Ra ≥ 90 3000K	24D 24°
	7W	940 Ra ≥ 90 4000K	36D 36°



# HG Series

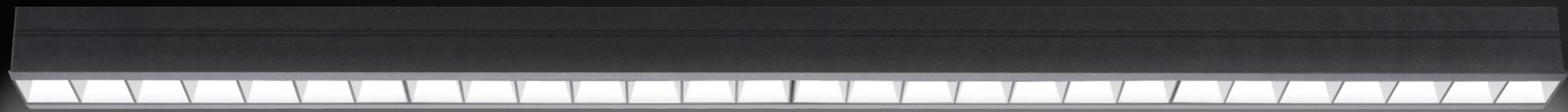

## Linear LED Lighting Solutions

	HG Series	
Model	 CXS2530S	 CXR3030S
Installation	Surface-mounted	Recessed
Type	LED SMD 2835	
Length & Wattage	300mm ( 7W ) / 600mm ( 14W ) / 900mm ( 21W ) / 1200mm ( 28W )	
CRI	Ra≥90	
CCT	3000K / 4000K	
Beam	30° / 60° / 90°	
Luminous Flux	420lm (7W) / 850lm (14W) / 1300lm (21W) / 1800lm (28W)	
Finish	Sanded black body , and matt black louvers	Sanded black body , and matt black louvers
Material	Extruded aluminum body ,PMMA lens and PC louvers	
Mounting accessories included	 Fixed mounting clips  Adjustable mounting clips	/

	HG Series	
Model	 CXS2530	 CXR3030
Installation	Surface-mounted	Recessed
Type	LED SMD 2835	
Length & Wattage	300mm ( 7W ) / 600mm ( 14W ) / 900mm ( 21W ) / 1200mm ( 28W )	
CRI	Ra≥90	
CCT	3000K / 4000K	
Beam	Wall washing	
Luminous Flux	420lm (7W) / 850lm (14W) / 1300lm (21W) / 1800lm (28W)	
Finish	Sanded black body and frosted lens	Sand black body and frosted lens
Material	Extruded aluminum body and PC lens	
Mounting accessories included	 Fixed mounting clips  Adjustable mounting clips	/

# Manchester

# Liverpool

Linear Wall Grazer

Linear Wall Washer



## Linear Wall Grazer

### Wall Grazing

Lighting effect where a wall with an irregular surface is illuminated so that there are both highlighted and shaded areas. This effect is only possible on walls with granular surfaces, such as those built from stone or exposed brick.

### Wall Washing

Lighting effect where a wall is illuminated so that surface irregularities are minimized, it seem smoother.

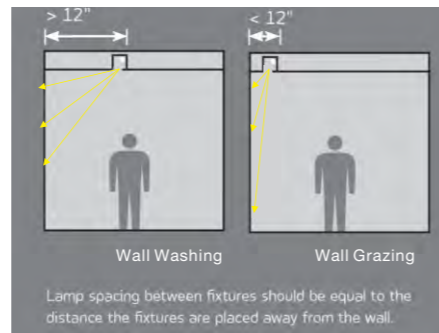

## Two kinds of installation: recessed or surface-mounted

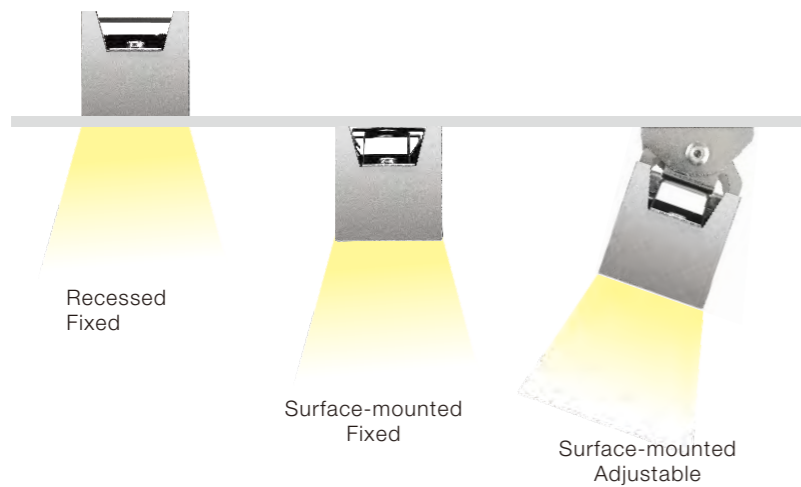

## Linear Wall Washer

### Four kinds of length

#### Grazer

	1.2M	28W
	0.9M	21W
	0.6M	14W
	0.3M	7W

#### Wall washer

	1.2M	28W
	0.9M	21W
	0.6M	14W
	0.3M	7W

### Two color temperatures



For wall washer and grazer, both fixed and adjustable mounting clips are included in the same package.

# Manchester



## CXS2530S

- Wattage** : 7W / 14W / 21W / 28W
- CRI** : Ra ≥ 90
- CCT** : 3000K / 4000K
- Beam** : 30° / 60° / 90°
- Finish** : Sanded black body, and matt black louvers
- Material** : Extruded aluminum body, PMMA lens and PC louvers
- Driver** : DC 24V constant voltage remote  
LED driver excluded

Linear Wall Grazer ( Surface-mounted )

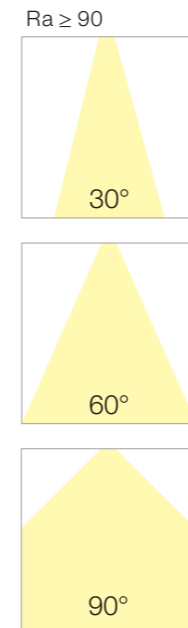
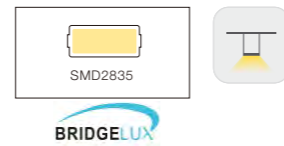
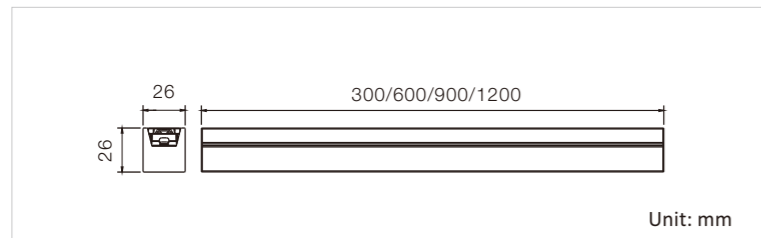

This series of products can be used for general lighting according to the requirement .

### Wiring diagram

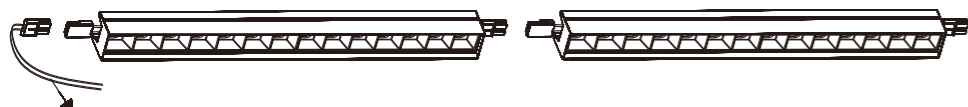

Connect to the remote constant voltage driver

### Technical parameters

Model	CXS2530S/03	CXS2530S/06	CXS2530S/09	CXS2530S/12
LEDs	LED SMD 2835			
Wattage	7W	14W	21W	28W
Lumen	420lm	850lm	1300lm	1800lm
Input Voltage	DC 24V			
Length	300mm	600mm	900mm	1200mm

### Accessories

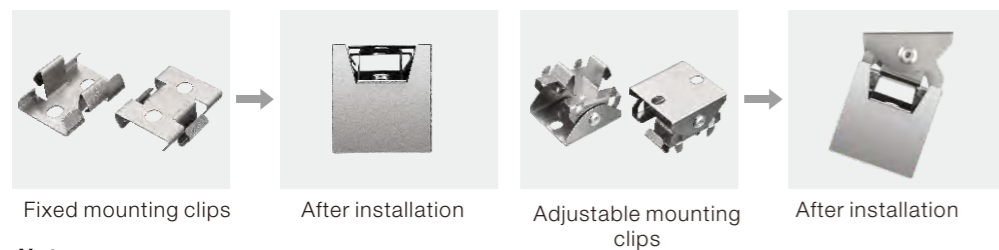

**Notes:**  
For wall washer and grazer, both fixed and adjustable mounting clips are included in the same package.

### CXS2530S-03

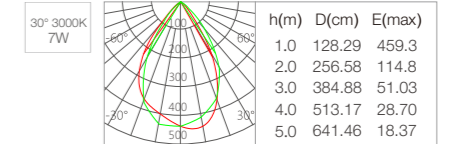
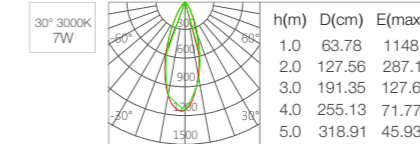

### CXS2530S-06

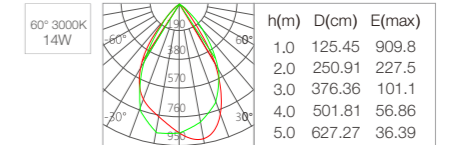
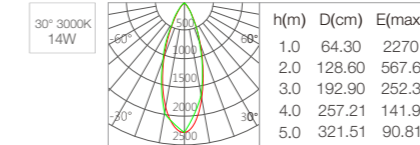

### CXS2530S-09

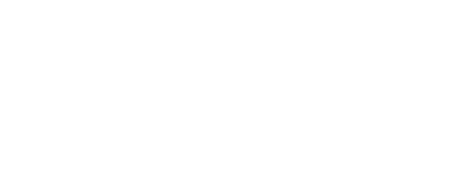
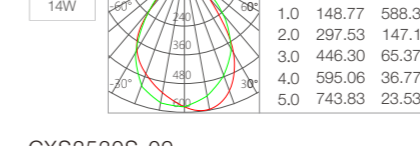

### CXS2530S-09

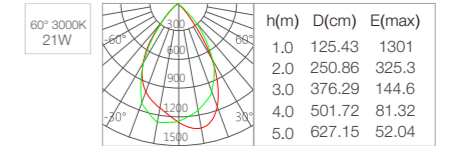
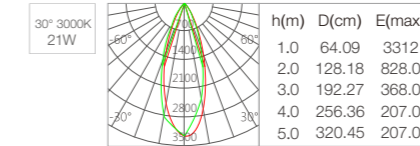

### CXS2530S-09

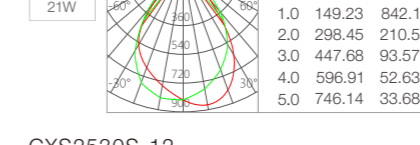

### CXS2530S-12

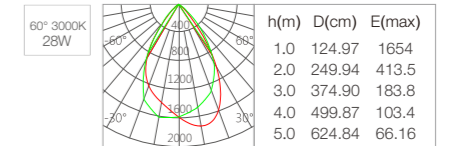
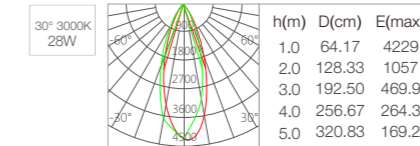

### CXS2530S-12

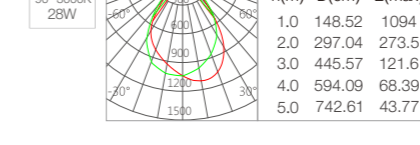

## ORDERING INFORMATION: LED fixture only. LED driver should be ordered separately.

**Example:** CXS2530S/03/7W/930/30D/ND

Model	Length	Wattage	CRI & CCT	Beam	Dimming
CXS2530S	03	7W	930	WW	ND
CXS2530S	03	300mm	7W	30D 30°	ND Non Dim
	06	600mm	14W	60D 60°	TD Triac Dim
	09	900mm	21W	90D 90°	VD 0/1-10V Dim
	12	1200mm	28W		DD DALL Dim

# Manchester



## CXR3030S

- Wattage** : 7W / 14W / 21W / 28W
- CRI** : Ra ≥ 90
- CCT** : 3000K / 4000K
- Beam** : 30° / 60° / 90°
- Finish** : Sanded black body, and matt black louvers
- Material** : Extruded aluminum body, PMMA lens and PC louvers
- Driver** : DC 24V constant voltage remote LED driver excluded

**Suitable for 5-20mm thick ceiling board**

Linear Wall Grazer (Recessed)

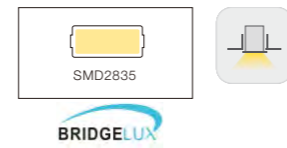
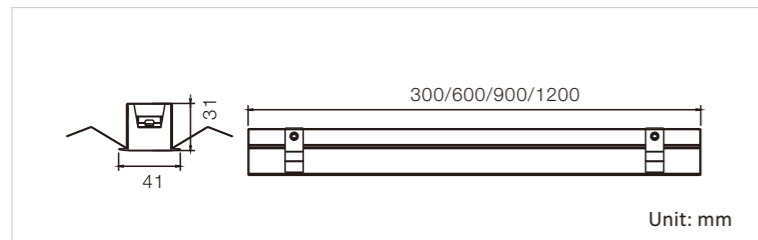

This series of products can be used for general lighting according to the requirement.

### Wiring diagram

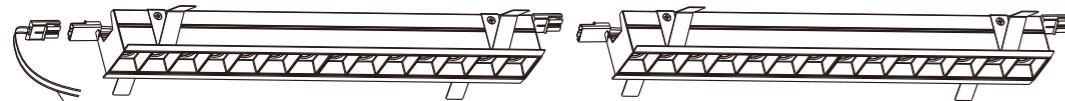

Connect to the remote constant voltage driver

### Technical parameters

Model	CXR3030S-03	CXR3030S-06	CXR3030S-09	CXR2530S-12
LEDs	LED SMD 2835			
Wattage	7W	14W	21W	28W
Lumen	420lm	850lm	1300lm	1800lm
Input Voltage	DC 24V			
Length	300mm	600mm	900mm	1200mm

Ra ≥ 90

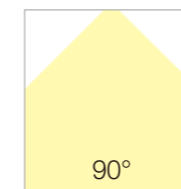
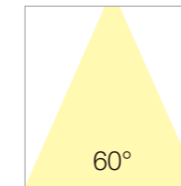
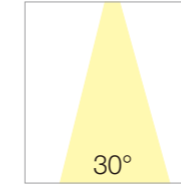

### CXR3030S-03

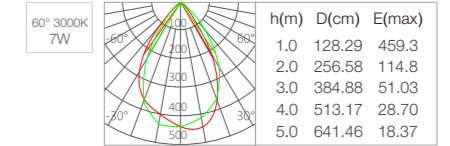
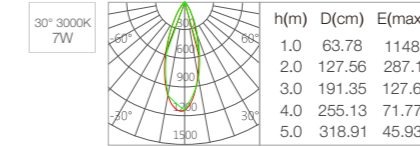

### CXR3030S-06

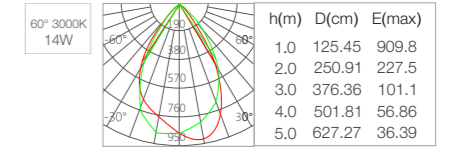
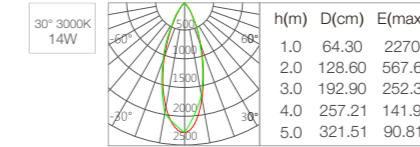

### CXR3030S-09

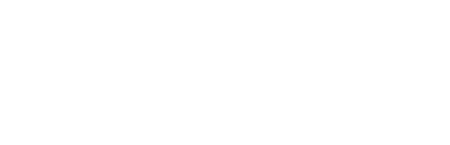
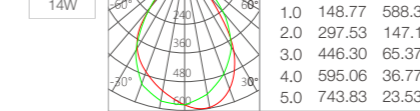

### CXR3030S-09

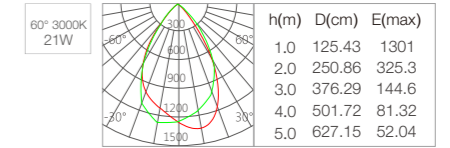
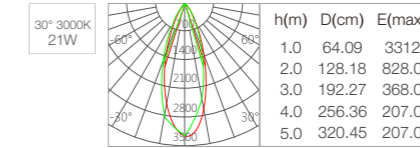

### CXR3030S-09

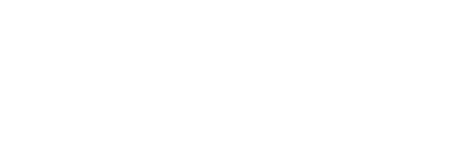
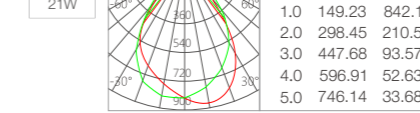

### CXR3030S-12

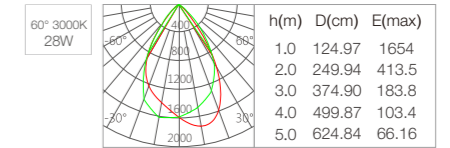
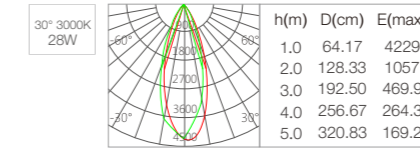

### CXR3030S-12

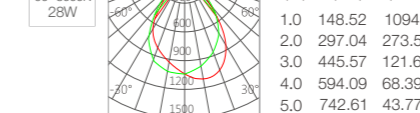

## ORDERING INFORMATION: LED fixture only. LED driver should be ordered separately.

**Example:** CXR3030S/03/7W/930/30D/ND

Model	Length	Wattage	CRI & CCT	Beam	Dimming
<b>CXR3030S</b>	<b>03</b>	<b>7W</b>	<b>930</b>	<b>30D</b>	<b>ND</b>
CXR3030S	03 300mm	7W	930 Ra≥90 3000K	30D 30°	ND Non Dim
	06 600mm	14W	940 Ra≥90 4000K	60D 60°	TD Triac Dim
	09 900mm	21W		90D 90°	VD 0/1-10V Dim
	12 1200mm	28W			DD DALL Dim

# Liverpool



## CXS2530

- Wattage** : 7W / 14W / 21W / 28W
- CRI** : Ra ≥ 90
- CCT** : 3000K / 4000K
- Beam** : Wall washing
- Finish** : Sanded black body and frosted lens
- Material** : Extruded aluminum body and PC lens
- Driver** : DC 24V constant voltage remote  
LED driver excluded

Linear Wall Washer ( Surface-mounted )

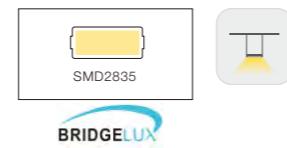
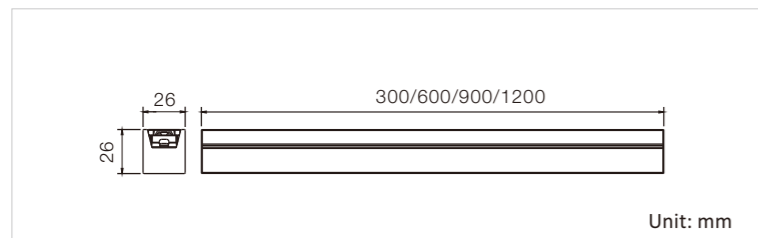

60°x100° beam is optional for general lighting by replacing the lens.

### Wiring diagram



Connect to the remote constant voltage driver

### Technical parameters

Model	CXS2530-03	CXS2530-06	CXS2530-09	CXS2530-12
LEDs	LED SMD 2835			
Wattage	7W	14W	21W	28W
Lumen	420lm	850lm	1300lm	1800lm
Input Voltage	DC 24V			
Length	300mm	600mm	900mm	1200mm

### Accessories

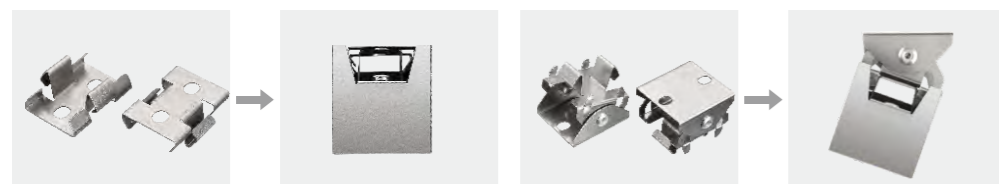

Fixed mounting clips After installation Adjustable mounting clips After installation

**Notes:**  
For wall washer and grazer, both fixed and adjustable mounting clips are included in the same package.

Ra ≥ 90

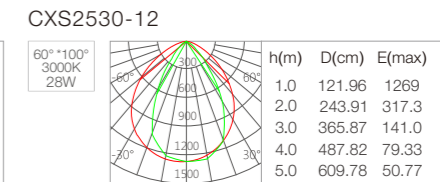
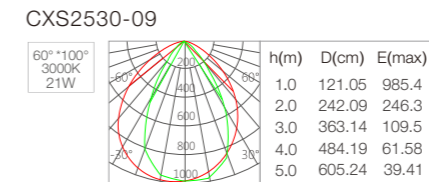
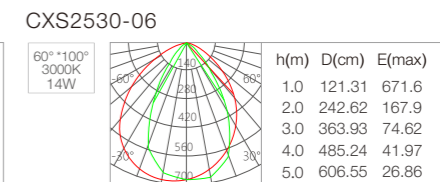
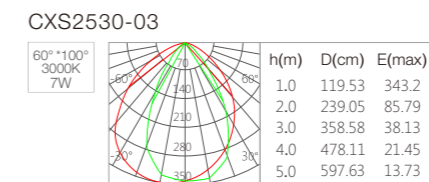
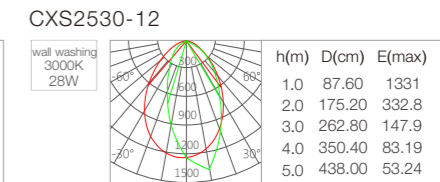
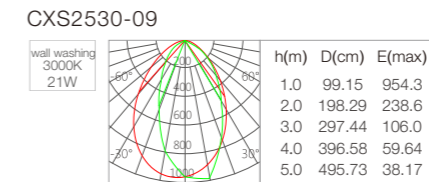
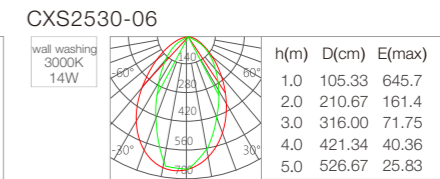
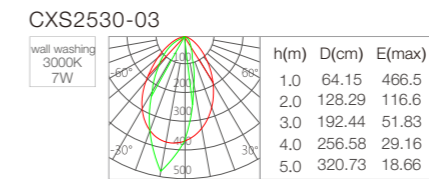

## ORDERING INFORMATION: LED fixture only. LED driver should be ordered separately.

**Example:** CXS2530/03/7W/930/WW/ND

Model	Length	Wattage	CRI & CCT	Beam	Dimming
CXS2530	03	7W	930	WW	ND
CXS2530	06	14W	940	60Dx100D	TD
CXS2530	09	21W			VD
CXS2530	12	28W			DD

# Liverpool



## CXR3030

- Wattage** : 7W / 14W / 21W / 28W
- CRI** : Ra ≥ 90
- CCT** : 3000K / 4000K
- Beam** : Wall washing
- Finish** : Sanded black body and frosted lens
- Material** : Extruded aluminum body and PC lens
- Driver** : DC 24V constant voltage remote  
LED driver excluded

**Suitable for 5-20mm thick ceiling board**

Linear Wall Washer ( Recessed )

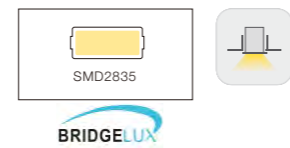
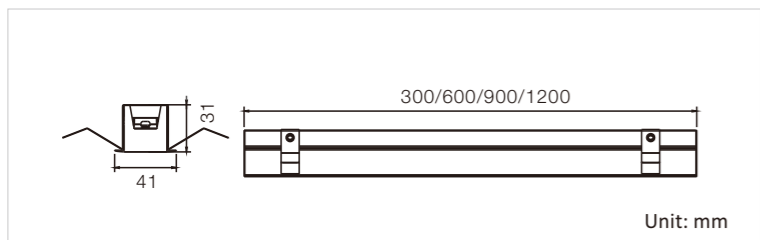

60°x100° beam is optional for general lighting by replacing the lens.

### Wiring diagram

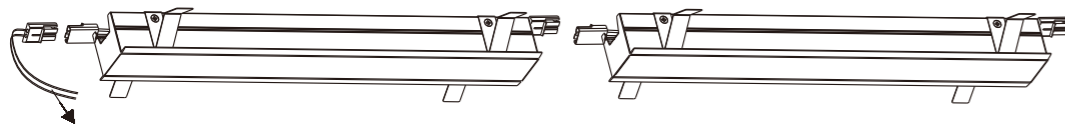

Connect to the remote constant voltage driver

### Technical parameters

Model	CXR3030-03	CXR3030-06	CXR3030-09	CXR3030-12
LEDs	LED SMD 2835			
Wattage	7W	14W	21W	28W
Lumen	420lm	850lm	1300lm	1800lm
Input Voltage	DC 24V			
Length	300mm	600mm	900mm	1200mm

Ra ≥ 90



Wall washing



60°x100°  
General lighting

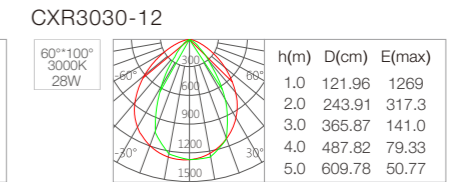
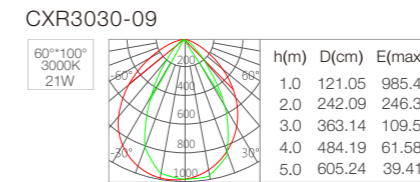
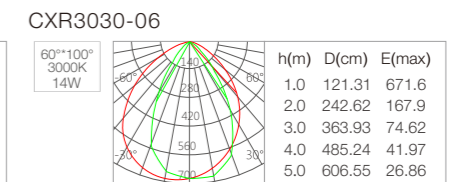
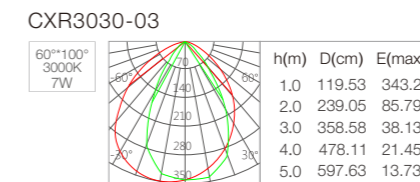
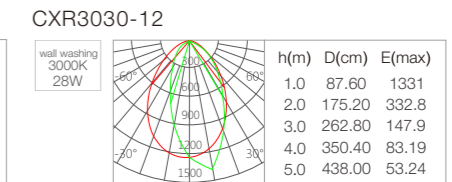
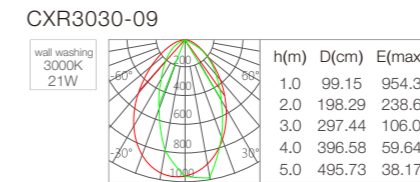
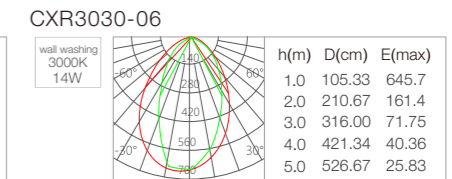
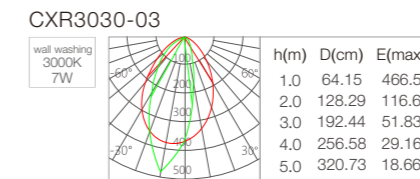

## ORDERING INFORMATION: LED fixture only. LED driver should be ordered separately.

**Example:** CXR3030/03/7W/930/WW/ND

Model	Length	Wattage	CRI & CCT	Beam	Dimming
<b>CXR3030</b>	<b>03</b>	<b>7W</b>	<b>930</b>	<b>WW</b>	<b>ND</b>
CXR3030	03 300mm	7W	930 Ra≥90 3000K	WW Wall Washer	ND Non Dim
	06 600mm	14W	940 Ra≥90 4000K	60Dx100D 60°x100°	TD Triac Dim
	09 900mm	21W			VD 0/1-10V Dim
	12 1200mm	28W			DD DALL Dim

# HP Series





## HP Series

This range of linear lighting can be installed in 3 kinds of ways: recessed, surface mounted and suspension.

Further more, to meet unique requirement for special application, we also designed trimless version for recessed installation.

To give various combination for different applications, we designed various cornering accessories, such as 90° connector, outward 90° connector inward 90° connector, T-shape connector, cross-shape connector. These connectors can link many linear lighting fixtures together according to designers' concept.

# Family matrix-profile

	Product series	Model	Installation	Sectional view	Application	Sectional dimension	Driver
Profile	8mm	CXS0810B	Surface-mounted			7.6*9mm	DC 24V Constant Voltage LED Driver
	17mm	CXS1715B	Surface-mounted			17*15mm	
		CXR1715B	Recessed			21.7*15mm	
		CXR1715BW	Recessed trimless			56*15mm	
		CXR1715W	Recessed (Convex corner)			52*23mm	
		CXR1715N	Recessed (Concave corner)			44.7*22mm	
		CXD1715B	Recessed (In-ground)			20*15mm	
		CXG1515C	Cornering (Arc-shaped)			15*15.7mm	
	25mm	CXS2530B	Surface-mounted			25*30mm	
		CXR2530B	Recessed			34*30mm	
	35mm	CXS3532B	Surface-mounted			33*33.5mm	Constant Current LED Driver included
		CXR3532B	Recessed			44*33.5mm	
		CXS3570B	Pendant			35*69.5mm	
	55mm	CXS5532B	Surface-mounted			55*34mm	
		CXR5532B	Recessed			65*34mm	
		CXS5570B	Pendant			55*73.5mm	
	75mm	CXS7532B	Surface-mounted			75*34mm	
		CXR7532B	Recessed			88*34mm	
		CXS7570B	Pendant			75*72.1mm	

Compatible lamp	"I" shape connector	"L" shape connector	Inward 90° connector	Outward 90° connector	"T" shape connector	Cross shape connector	Cornering accessories	
Flexible strip CEGB2216-50/A	—	—	—	—	—	—		
Flexible strip CEGB2835-50/A (to be ordered separately)	—	—	—	—	—	—	"L" shape connector L90 	
	—	—	—	—	—	—	"T" shape connector T90 	
	—	—	—	—	—	—	Outward 90° connector 	
	√	√	—	—	—	—	Inward 90° connector 	
	√	√	—	—	—	—		
	Rigid LED bar included	√	√	√	√	√	√	Cross shape connector X90 
		√	√	√	√	√	√	
		√	√	√	√	√	√	
		√	√	√	√	√	√	"I" shape connector 
		√	√	√	√	√	√	
√		√	√	√	√	√		

## Family matrix-lamp & driver

	Picture						
Lamp	Model	CEGB2216-50/A	CEGB2835-50/A	CXS3532-X	CXS5532-X	CXS7532-X	
	Wattage	8W/m	14W/m	20W	30W	45W	
	CCT	4000K/6000K			4000K / 5600K		
	CRI	Ra≥80			Ra≥80		
	Luminous Flux	700lm/m	1100lm/m	1800lm	2600lm	3600lm	
	LEDs/meter	240/m	120/m		240/m	288/m	
	Input Voltage	DC 24V			DC 36V		
	Input Current	/			500mA	700mA	1050mA
	Dimension(W*L)	5mm*5000mm	10mm*5000mm	22mm*1000mm	34mm*1000mm	50mm*1000mm	
	IP Rating	IP 20/IP 65			IP 20		
	Minimum order length	25mm	50mm	200mm			
Suitable profile	CXS0810B	CXS1715B CXR1715B CXR1715BW CXR1715N CXR1715W CXD1715B CXG1515C CXS2530B CXR2530B	CXS3570B CXS3532B CXR3532B	CXS7570B CXS7532B CXR7532B			

	Picture					
Driver	Type	Constant Voltage LED Driver			Constant Current LED Driver	
	Model	CVD/80/24	CVD/150/24	CCD/18/500/25~41	CCD/NF/28/700/25~41	CCD/NF/43/1050/25~41
	Wattage	80W	150W	20W	28W	43W
	P F	PF≥0.5			PF≥0.9	
	Input Voltage	AC 220V-240V				
	Dimension (W*L)	48mm*195mm	68mm*223mm	45mm*115mm		45mm*140mm
	IP Rating	IP 20				
	Suitable profile	CXS0810B CXS1715B CXR1715B CXR1715BW CXR1715N	CXR1715W CXD1715B CXG1515C CXS2530B CXR2530B	CXS3570B CXS3532B CXR3532B	CXS5570B CXS5532B CXR5532B	CXS7570B CXS7532B CXR7532B

Flexible diffuser make 20 meters long seamless connection can be available.



V shape joint design, to avoid light leakage between the connection.

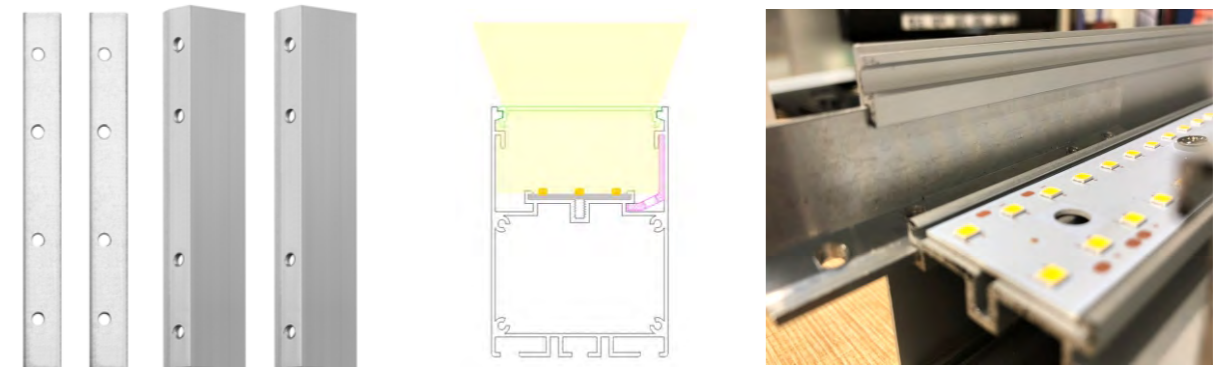

The length can be cut, according to the site condition.

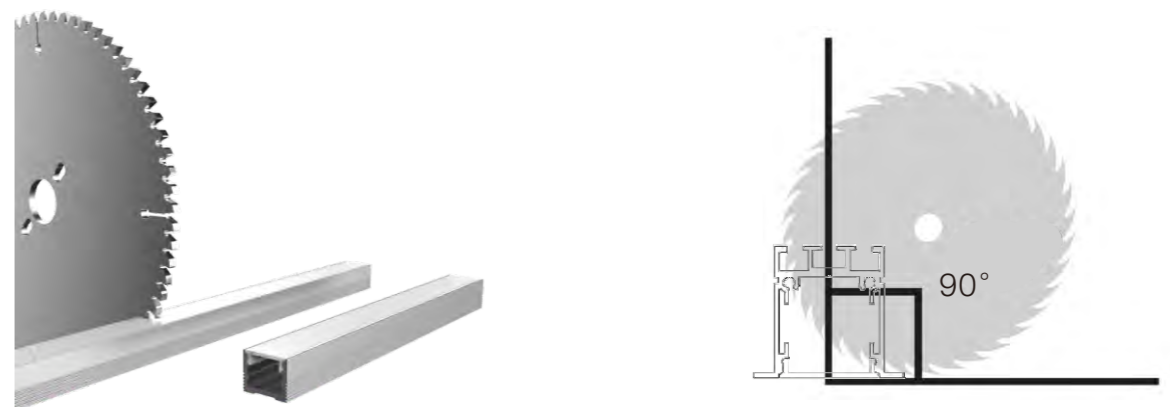

Various of joining accessories can give customers various combinations of linear lighting, and then produce flexible lighting effects for different applications.

Joining accessories including

- 90° connector
- inward 90° connector
- outward 90° connector
- Cross-shape connector

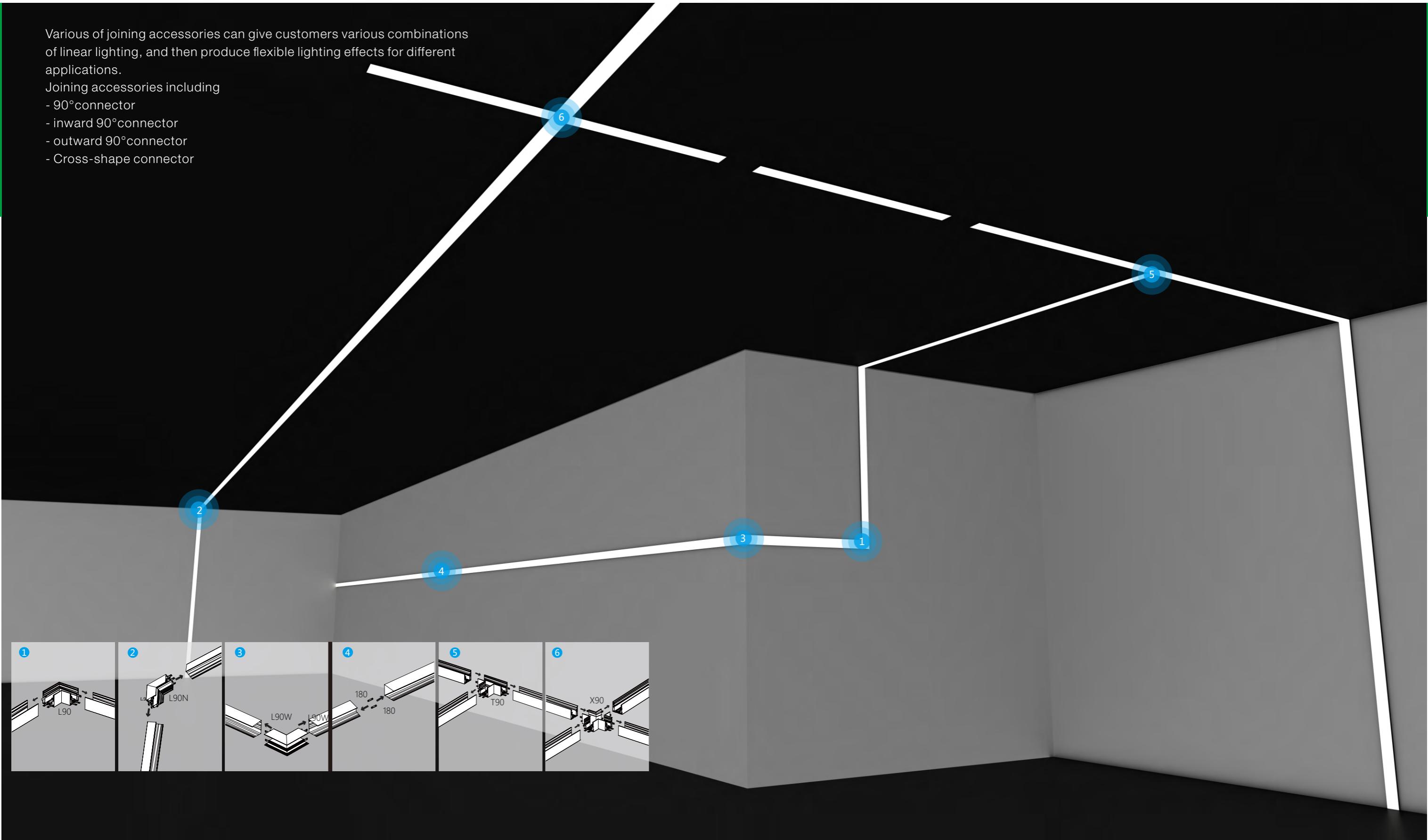

# Vienna

## 8mm Series



-  Indoor use
-  General lighting
-  Low energy consumption
-  Anti-glare
-  Precise light distribution
-  Flicker-free
-  Long life
-  IP 20

# Vienna



### CXS0810B

- Wattage** : Max 10W/m
- CRI** : Ra ≥ 80
- CCT** : 4000K / 6000K
- Lumen** : 700lm/m
- Finish** : SW / SB / AA
- Material** : Extruded aluminum body and milky white PC
- Driver** : Constant voltage LED driver excluded

Surface mounted

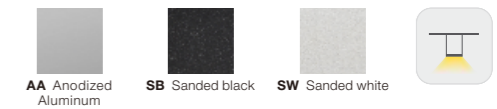
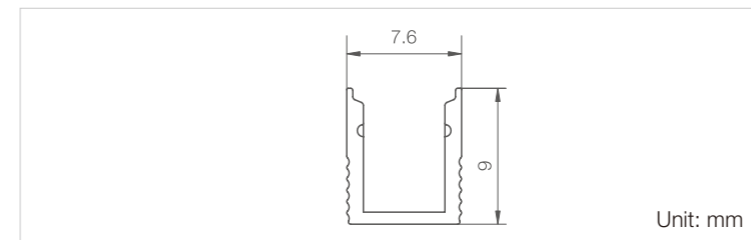

Flexible strip



CEGB2216-50/A  
8W/m

Driver (to be ordered separately)



Constant Voltage LED Driver  
CVD/80/24  
80W



Constant Voltage LED Driver  
CVD/150/24  
150W

**ORDERING INFORMATION:** Constant voltage LED driver should be ordered separately.







**Example:** CXS0810B/05/8W/m/840

Model	Length	Lamp	CRI & CCT
CXS0810B	05	8W/m	840
CXS0810B	05 500mm 10 1000mm 20 2000mm	8W/m CEGB2216-50/A	840 Ra ≥ 80 4000K 860 Ra ≥ 80 6000K

# Vienna

## 17mm Series



-  Indoor use
-  General lighting
-  Low energy consumption
-  Anti-glare
-  Precise light distribution
-  Flicker-free
-  Long life
-  IP 20

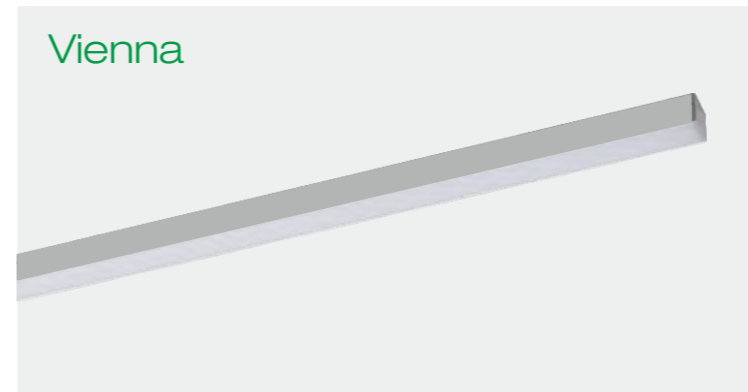

- CXS1715B**
- Wattage** : Max 15W/m
  - CRI** : Ra ≥ 80
  - CCT** : 4000K / 6000K
  - Lumen** : 1100lm/m
  - Finish** : SW / SB / AA
  - Material** : Extruded aluminum body and milky white PC
  - Driver** : Constant voltage LED driver excluded

Surface mounted

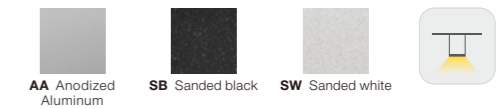
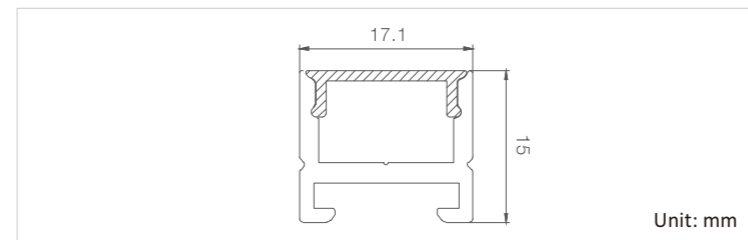

Flexible strip



CEGB2835-50/A  
14W/m



Flexible diffuser  
CEP1715B

Driver (to be ordered separately)



Constant Voltage LED Driver  
CVD/80/24  
80W

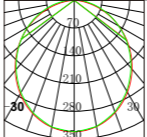

Constant Voltage LED Driver  
CVD/150/24  
150W

15W 4000K		h(m)	Ea(x)	E(max)	D(cm)
	1	109.8	331.5	264.64	
	2	27.46	82.88	529.28	
	3	12.20	36.84	793.92	
	4	6.864	20.72	1058.57	
	5	4.393	13.26	1323.21	

**ORDERING INFORMATION:** Constant voltage LED driver should be ordered separately.

**Example:** CXS1715B/05/14W/m/840

Model	Length	Lamp	CRI & CCT
<b>CXS1715B</b>	<b>05</b>	<b>14W/m</b>	<b>840</b>
CXS1715B	05 500mm	14W/m	840 Ra ≥ 80 4000K
	10 1000mm	CEGB2835-50/A	860 Ra ≥ 80 6000K
	20 2000mm		

Vienna

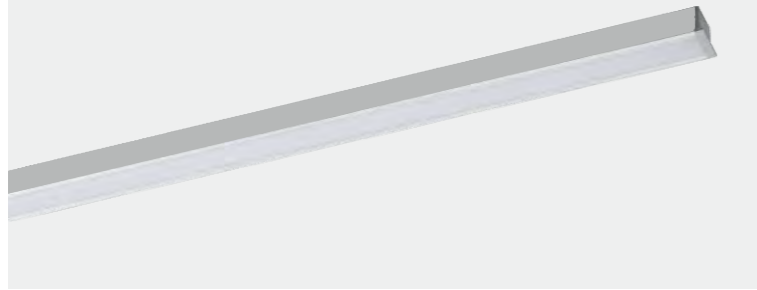

**CXR1715B**

- Wattage** : Max 15W/m
- CRI** : Ra ≥ 80
- CCT** : 4000K / 6000K
- Lumen** : 1100lm/m
- Finish** : SW / SB / AA
- Material** : Extruded aluminum body and milky white PC
- Driver** : Constant voltage LED driver excluded

Recessed

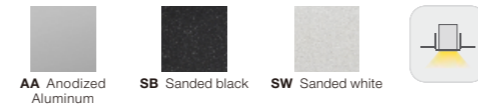
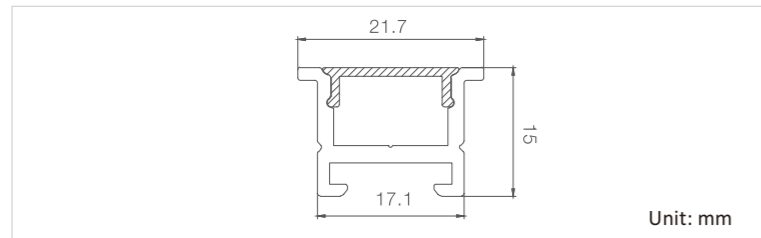

Flexible strip



CEGB2835-50/A  
14W/m



Flexible diffuser  
CEP1715B

Driver (to be ordered separately)



Constant Voltage LED Driver  
CVD/80/24  
80W



Constant Voltage LED Driver  
CVD/150/24  
150W

**ORDERING INFORMATION:** Constant voltage LED driver should be ordered separately.

**Example:** CXR1715B/05/14W/m/830

Model	Length	Lamp	CRI & CCT
CXR1715B	05	14W/m	830
CXR1715B	05 500mm	14W/m CEGB2835-50/A	830 Ra ≥ 80 3000K
	10 1000mm		840 Ra ≥ 80 4000K
	20 2000mm		860 Ra ≥ 80 6000K

Vienna

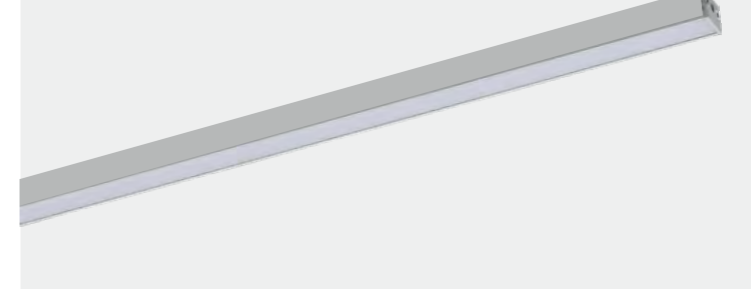

**CXD1715B**

- Wattage** : Max 15W/m
- CRI** : Ra ≥ 80
- CCT** : 4000K / 6000K
- Lumen** : 1100lm/m
- Finish** : SW / SB / AA
- Material** : Extruded aluminum body and milky white PC
- Driver** : Constant voltage LED driver excluded

Recessed (In-ground)

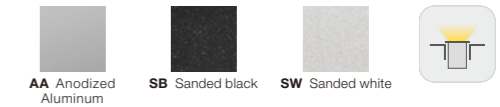
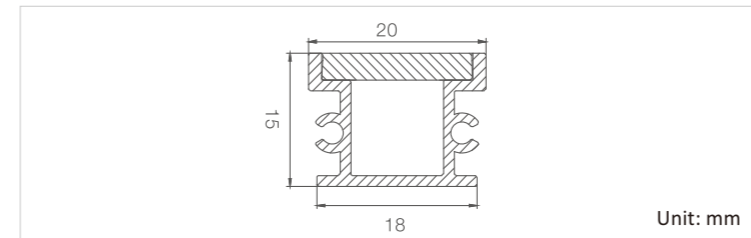

Flexible strip



CEGB2835-50/A  
14W/m

Driver (to be ordered separately)



Constant Voltage LED Driver  
CVD/80/24  
80W



Constant Voltage LED Driver  
CVD/150/24  
150W

15W 4000K	Beam Angle	h(m)	Ea(lx)	E(max)	D(cm)
80	1	51.43	179.6	306.03	
120	2	12.86	44.91	612.07	
160	3	5.714	19.96	918.10	
200	4	3.214	11.23	1224.14	
	5	2.057	7.185	1530.17	



**ORDERING INFORMATION:** Constant voltage LED driver should be ordered separately.

**Example:** CXD1715B/05/14W/m/830

Model	Length	Lamp	CRI & CCT
CXD1715B	05	14W/m	830
CXD1715B	05 500mm	14W/m CEGB2835-50/A	830 Ra ≥ 80 3000K
	10 1000mm		840 Ra ≥ 80 4000K
	20 2000mm		860 Ra ≥ 80 6000K

# Vienna

## 25mm Series



- Indoor use
- General lighting
- Low energy consumption
- Anti-glare
- Precise light distribution
- Flicker-free
- Long life
- IP 20

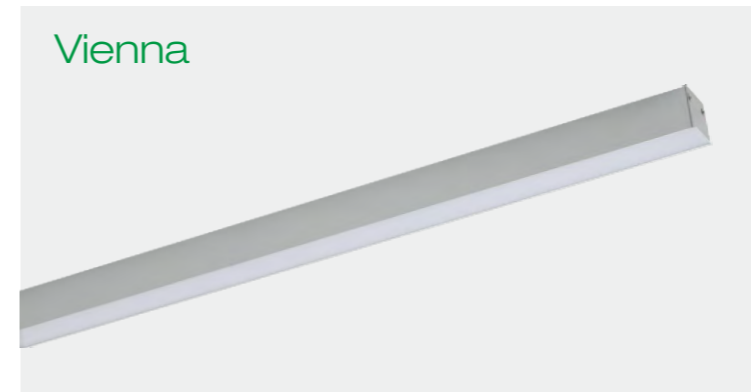

- CXS2530B**
- Wattage** : Max 15W/m
  - CRI** : Ra ≥ 80
  - CCT** : 4000K / 6000K
  - Lumen** : 1100lm/m
  - Finish** : SW / SB / AA
  - Material** : Extruded aluminum body and milky white PC
  - Driver** : Constant voltage LED driver excluded

Surface mounted

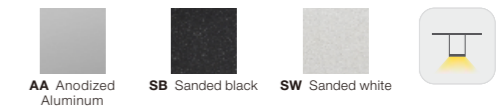
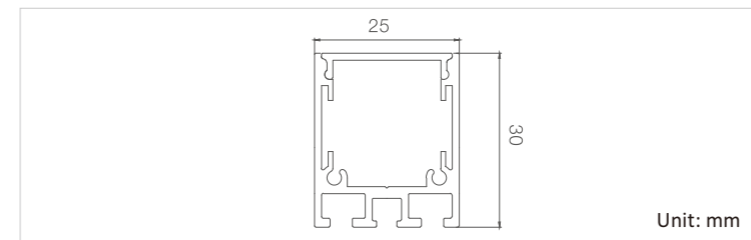

Flexible strip



CEGB2835-50/A  
14W/m



Flexible diffuser  
CEP2530B

Driver (to be ordered separately)



Constant Voltage LED Driver  
CVD/80/24  
80W



Constant Voltage LED Driver  
CVD/150/24  
150W

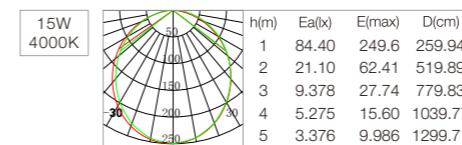

**ORDERING INFORMATION:** Constant voltage LED driver should be ordered separately.

**Example:** CXS2530B/05/14W/m/840

Model	Length	Lamp	CRI & CCT
<b>CXS2530B</b>	<b>05</b>	<b>14W/m</b>	<b>840</b>
CXS2530B	05 500mm	14W/m	840 Ra ≥ 80 4000K
	10 1000mm	CEGB2835-50/A	860 Ra ≥ 80 6000K
	20 2000mm		



Vienna

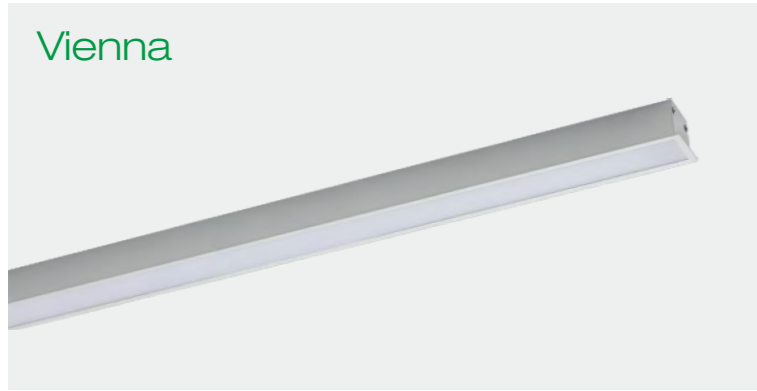

**CXR2530B**

- Wattage** : Max 15W/m
- CRI** : Ra ≥ 80
- CCT** : 4000K / 6000K
- Lumen** : 1100lm/m
- Finish** : SW / SB / AA
- Material** : Extruded aluminum body and milky white PC
- Driver** : Constant voltage LED driver excluded

Recessed

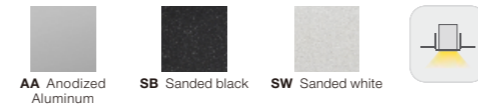
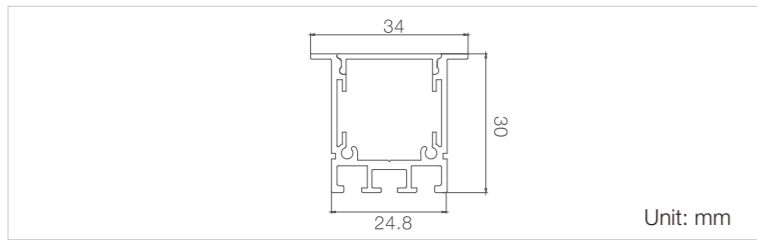

Flexible strip



CEGB2835-50/A  
14W/m



Flexible diffuser  
CEP2530B

Driver (to be ordered separately)



Constant Voltage LED Driver  
CVD/80/24  
80W



Constant Voltage LED Driver  
CVD/150/24  
150W

**ORDERING INFORMATION:** Constant voltage LED driver should be ordered separately.

**Example:** CXR2530B/05/14W/m/840

Model	Length	Lamp	CRI & CCT
CXR2530B	05	14W/m	840
CXR2530B	05 500mm	14W/m	840 Ra ≥ 80 4000K
	10 1000mm		860 Ra ≥ 80 6000K
	20 2000mm		



# Vienna

35mm Series

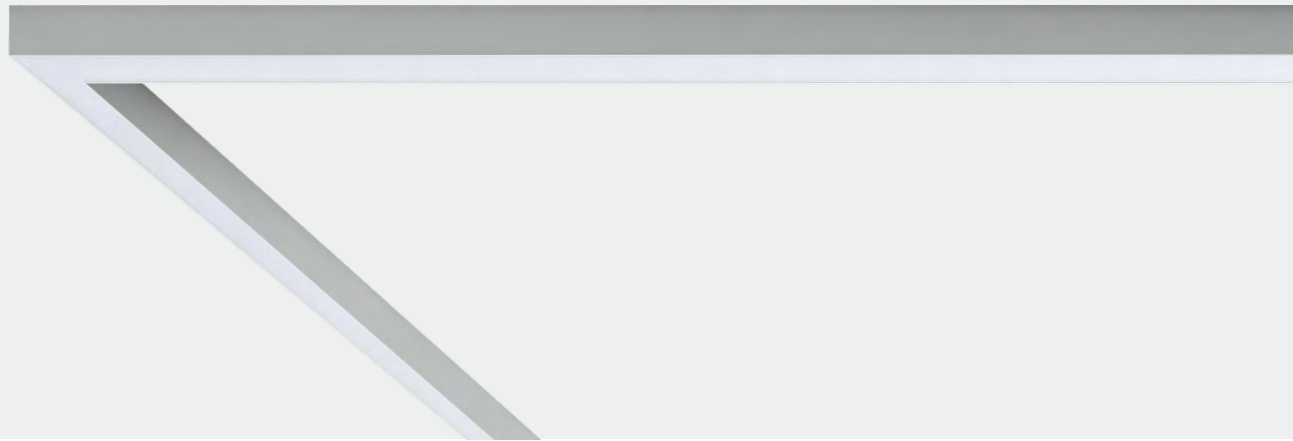

-  Indoor use
-  General lighting
-  Low energy consumption
-  Anti-glare
-  Precise light distribution
-  Flicker-free
-  Long life
-  IP 20



Vienna



Surface mounted

**CXS3532B**

- Wattage** : 10W(0.6m) 20W(1.2m)
- CRI** : Ra ≥ 80
- CCT** : 4000K/5600K
- Lumen** : 750lm(0.6m) 1500lm(1.2m)
- Finish** : SW / SB / AA
- Material** : Extruded aluminum body and milky white PC
- Driver** : Remote constant current LED driver included

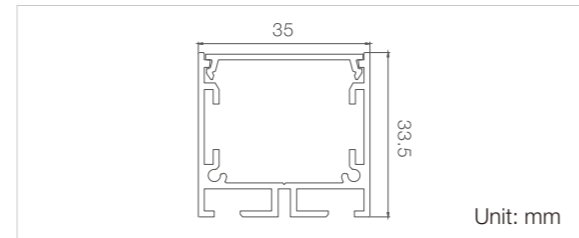

Accessories for connection (to be ordered separately)



"I" shape connector Flexible diffuser CEP3532B "L" shape connector L90

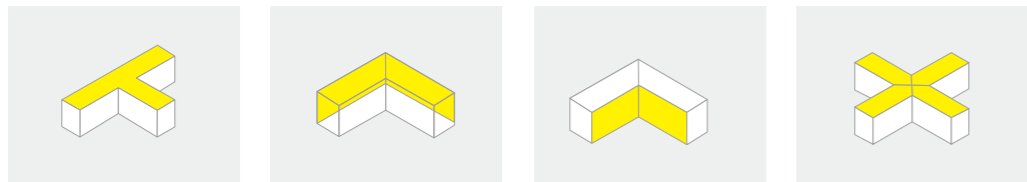
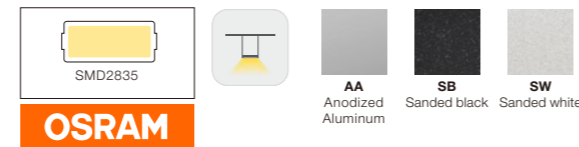

"T" shape connector T90 Outward 90° connector Inward 90° connector Cross shape connector X90

Technical parameters

Type	Linear Profile	Accessories for connection				
Model	CXS3532B	CXS3532B-L90	CXS3532B-L90N	CXS3532B-L90W	CXS3532B-T90	CXS3532B-X90
LEDs	SMD 2835					
Wattage	10W/20W	5W		7W	9W	
Lumen	750lm/1500lm	370lm		520lm	670lm	
Dimension	600*35*33.5mm 1200*35*33.5mm	125*125*33.5mm		215*125*33.5mm	215*215*33.5mm	

**ORDERING INFORMATION:**

Example: CXS3532B/06/10W/840/ND

Model	Length	Lamp	CRI & CCT	Dimming
CXS3532B	06	10W	840	ND
CXS3532B	06 600mm	10W	840 Ra ≥ 80 4000K	ND Non Dim
	12 1200mm	20W	856 Ra ≥ 80 5600K	TD Triac Dim
				VD 0/1-10V Dim
				DD DALL Dim

Vienna



Recessed

**CXR3532B**

- Wattage** : 10W(0.6m) 20W(1.2m)
- CRI** : Ra ≥ 80
- CCT** : 4000K/5600K
- Lumen** : 750lm(0.6m) 1500lm(1.2m)
- Finish** : SW / SB / AA
- Material** : Extruded aluminum body and milky white PC
- Driver** : Remote constant current LED driver included

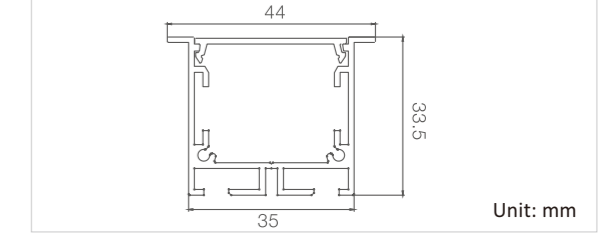

Accessories for connection (to be ordered separately)



"I" shape connector Flexible diffuser CEP3532B "L" shape connector L90

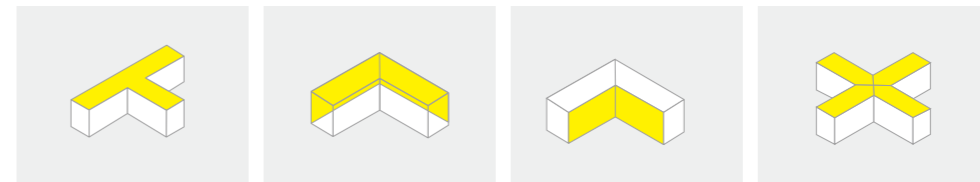
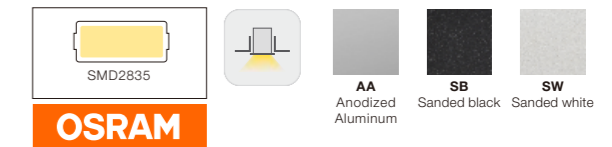

"T" shape connector T90 Outward 90° connector Inward 90° connector Cross shape connector X90

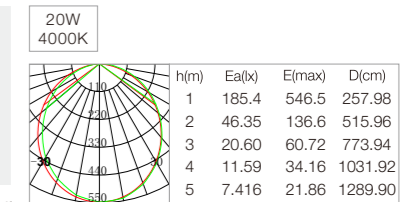

Technical parameters

Type	Linear Profile	Accessories for connection				
Model	CXR3532B	CXR3532B-L90	CXR3532B-L90N	CXR3532B-L90W	CXR3532B-T90	CXR3532B-X90
LEDs	SMD 2835					
Wattage	10W/20W	5W		7W	9W	
Lumen	750lm/1500lm	370lm		520lm	670lm	
Dimension	600*44*33.5mm 1200*44*33.5mm	129.5*125*33.5mm		215*129.5*33.5mm	215*215*33.5mm	

**ORDERING INFORMATION:**

Example: CXR3532B/06/10W/840/ND

Model	Length	Lamp	CRI & CCT	Dimming
CXR3532B	06	10W	840	ND
CXR3532B	06 600mm	10W	840 Ra ≥ 80 4000K	ND Non Dim
	12 1200mm	20W	856 Ra ≥ 80 5600K	TD Triac Dim
				VD 0/1-10V Dim
				DD DALL Dim

# Vienna

55mm Series

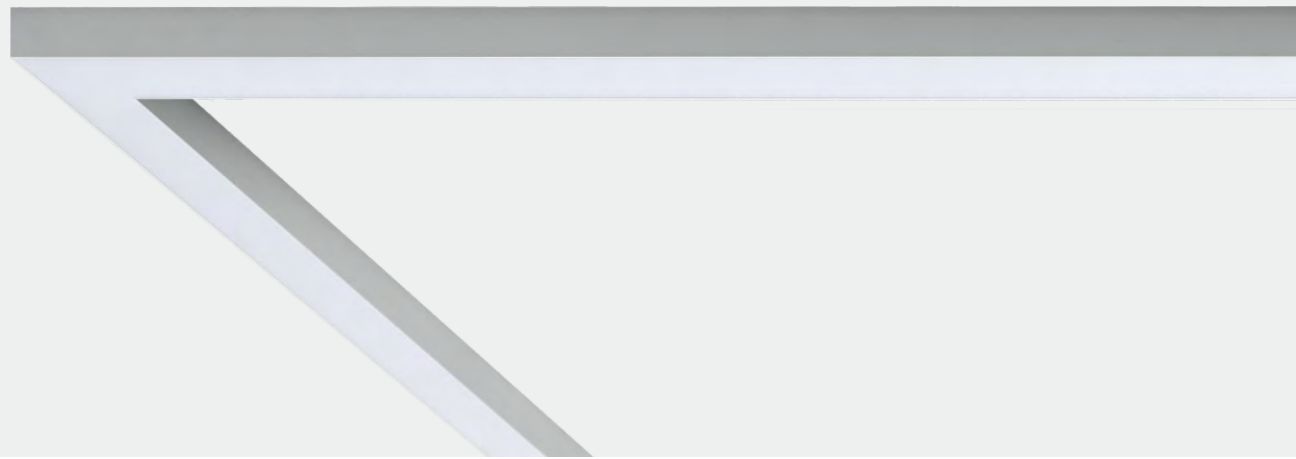

-  Indoor use
-  General lighting
-  Low energy consumption
-  Anti-glare
-  Precise light distribution
-  Flicker-free
-  Long life
-  IP 20



Vienna



Surface mounted

**CXS5532B**

**Wattage** : 15W(0.6m) 30W(1.2m)  
**CRI** : Ra ≥ 80  
**CCT** : 4000K/5600K  
**Lumen** : 900lm(0.6m) 1800lm(1.2m)  
**Finish** : SW / SB / AA  
**Material** : Extruded aluminum body and milky white PC  
**Driver** : Remote constant current LED driver included

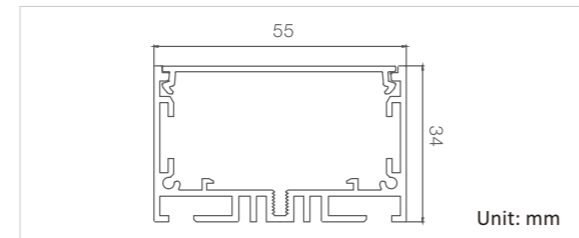

Accessories for connection (to be ordered separately)



"I" shape connector Flexible diffuser CEP3532B "L" shape connector L90

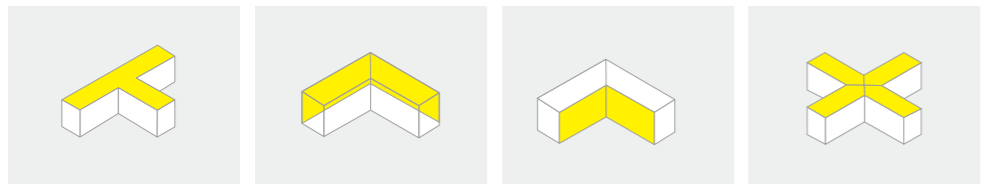

"T" shape connector T90 Outward 90° connector Inward 90° connector Cross shape connector X90

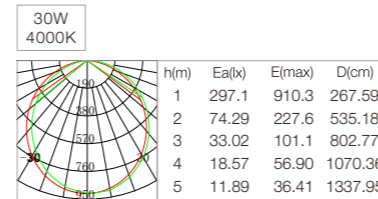
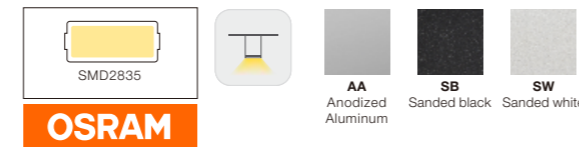

Technical parameters

Type	Linear Profile	Accessories for connection				
Model	CXS5532B	CXS5532B-L90	CXS5532B-L90N	CXS5532B-L90W	CXS5532B-T90	CXS5532B-X90
LEDs	SMD 2835					
Wattage	15W/30W	7W		9W	12W	
Lumen	900lm/1800lm	420lm		550lm	750lm	
Dimension	600*55*34mm 1200*55*34mm	160*160*34mm		265*160*34mm	265*265*34mm	

**ORDERING INFORMATION:**

Example: CXS5532B/06/15W/840/ND

Model	Length	Lamp	CRI & CCT	Dimming
<b>CXS5532B</b>	<b>06</b>	<b>15W</b>	<b>840</b>	<b>ND</b>
CXS5532B	06 600mm 12 1200mm	15W 30W	840 Ra ≥ 80 4000K 856 Ra ≥ 80 5600K	ND Non Dim TD Triac Dim VD 0/1-10V Dim DD DALL Dim

Vienna



Recessed

**CXR5532B**

**Wattage** : 15W(0.6m) 30W(1.2m)  
**CRI** : Ra ≥ 80  
**CCT** : 4000K/5600K  
**Lumen** : 900lm(0.6m) 1800lm(1.2m)  
**Finish** : SW / SB / AA  
**Material** : Extruded aluminum body and milky white PC  
**Driver** : Remote constant current LED driver included

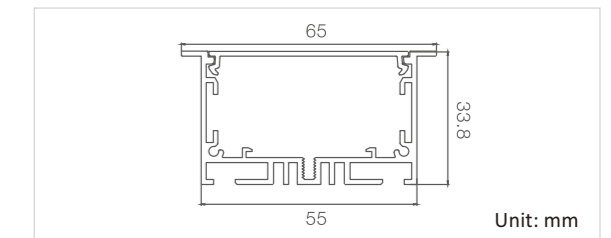

Accessories for connection (to be ordered separately)



"I" shape connector Flexible diffuser CEP3532B "L" shape connector L90

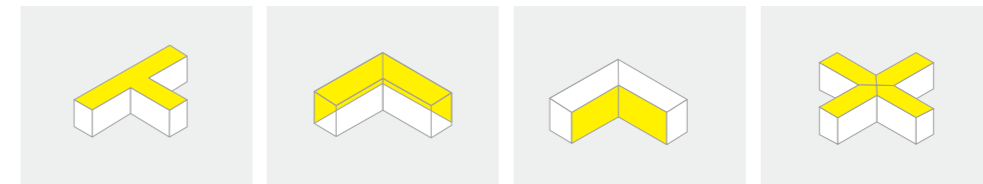

"T" shape connector T90 Outward 90° connector Inward 90° connector Cross shape connector X90

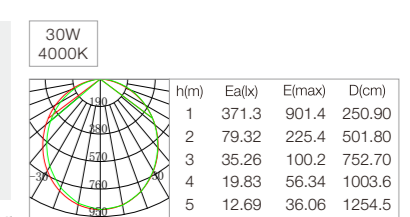
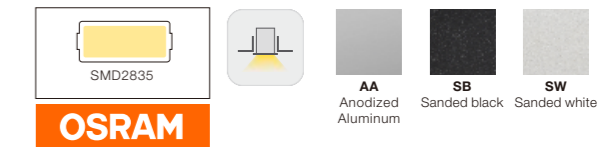

Technical parameters

Type	Linear Profile	Accessories for connection				
Model	CXR5532B	CXR5532B-L90	CXR5532B-L90N	CXR5532B-L90W	CXR5532B-T90	CXR5532B-X90
LEDs	SMD 2835					
Wattage	15W/30W	7W		9W	12W	
Lumen	900lm/1800lm	420lm		550lm	750lm	
Dimension	600*65*33.8mm 1200*65*33.8mm	160*160*34mm		265*165*34mm	265*265*34mm	

**ORDERING INFORMATION:**

Example: CXR5532B/06/15W/840/ND

Model	Length	Lamp	CRI & CCT	Dimming
<b>CXR5532B</b>	<b>06</b>	<b>15W</b>	<b>840</b>	<b>ND</b>
CXR5532B	06 600mm 12 1200mm	15W 30W	840 Ra ≥ 80 4000K 856 Ra ≥ 80 5600K	ND Non Dim TD Triac Dim VD 0/1-10V Dim DD DALL Dim

# Vienna 75mm Series

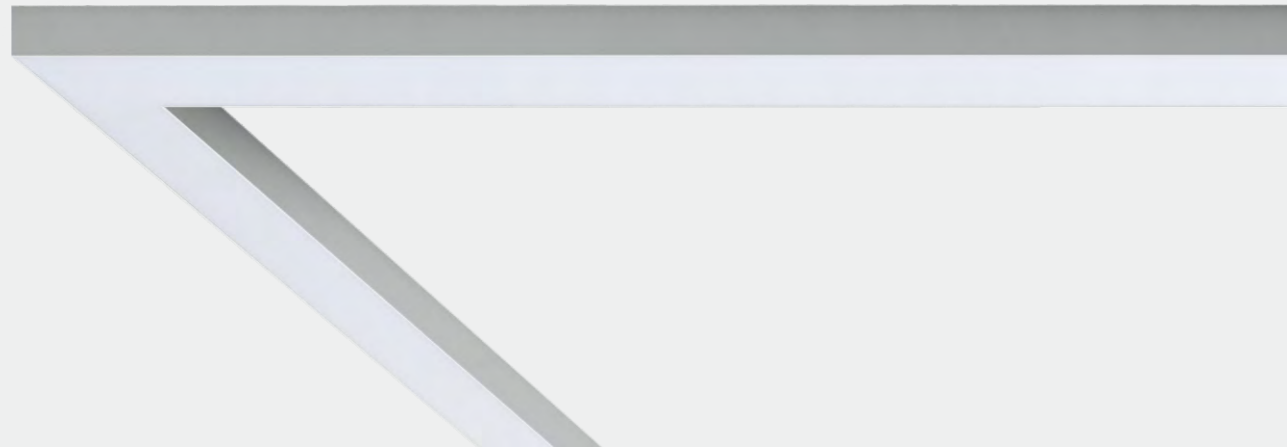

-  Indoor use
-  General lighting
-  Low energy consumption
-  Anti-glare
-  Precise light distribution
-  Flicker-free
-  Long life
-  IP 20



Vienna



Surface mounted

**CXS7532B**

**Wattage** : 23W(0.6m) 45W(1.2m)  
**CRI** : Ra ≥ 80  
**CCT** : 4000K/5600K  
**Lumen** : 1300lm(0.6m) 2700lm(1.2m)  
**Finish** : SW / SB / AA  
**Material** : Extruded aluminum body and milky white PC  
**Driver** : Remote constant current LED driver included

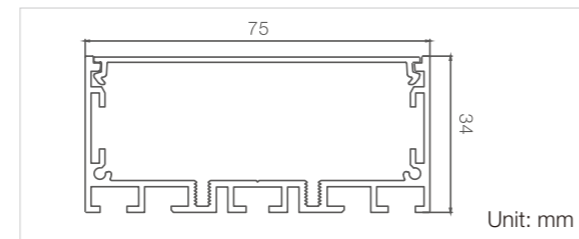

Accessories for connection (to be ordered separately)



"I" shape connector Flexible diffuser CEP7532B "L" shape connector L90

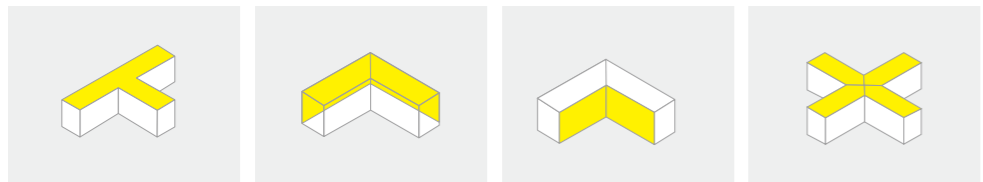

"T" shape connector T90 Outward 90° connector Inward 90° connector Cross shape connector X90

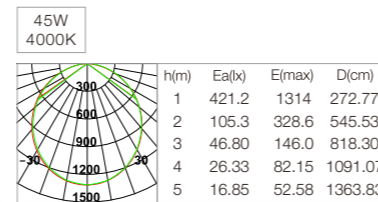
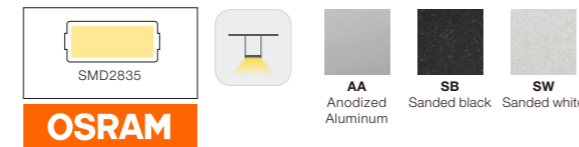

Technical parameters

Type	Linear Profile	Accessories for connection				
Model	CXS7532B	CXS7532B-L90	CXS7532B-L90N	CXS7532B-L90W	CXS7532B-T90	CXS7532B-X90
LEDs	SMD 2835					
Wattage	23W/45W	15W		20W	30W	
Lumen	1300lm/2700lm	900lm		1300lm	1800lm	
Dimension	600*75*34mm 1200*75*34mm	202*202*34mm		329*202*34mm	329*329*34mm	

**ORDERING INFORMATION:**

Example: CXS7532B/06/23W/840/ND

Model	Length	Lamp	CRI & CCT	Dimming
<b>CXS7532B</b>	<b>06</b>	<b>23W</b>	<b>840</b>	<b>ND</b>
CXS7532B	06 600mm 12 1200mm	23W 45W	840 Ra ≥ 80 4000K 856 Ra ≥ 80 5600K	ND Non Dim TD Triac Dim VD 0/1-10V Dim DD DALL Dim

Vienna



Recessed

**CXR7532B**

**Wattage** : 23W(0.6m) 45W(1.2m)  
**CRI** : Ra ≥ 80  
**CCT** : 4000K/5600K  
**Lumen** : 1300lm(0.6m) 2700lm(1.2m)  
**Finish** : SW / SB / AA  
**Material** : Extruded aluminum body and milky white PC  
**Driver** : Remote constant current LED driver included

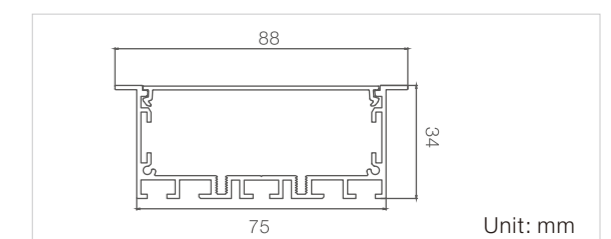

Accessories for connection (to be ordered separately)



"I" shape connector Flexible diffuser CEP7532B "L" shape connector L90

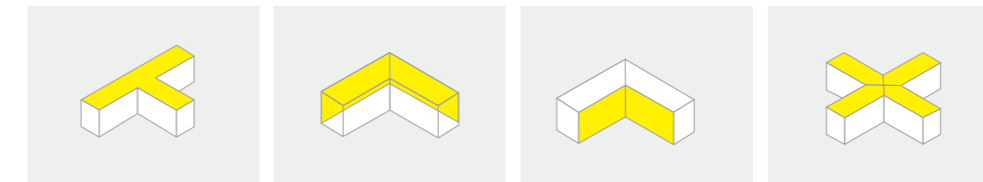

"T" shape connector T90 Outward 90° connector Inward 90° connector Cross shape connector X90

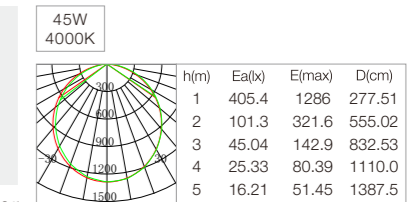
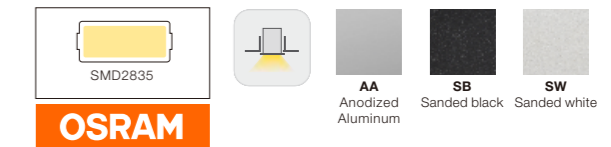

Technical parameters

Type	Linear Profile	Accessories for connection				
Model	CXR7532B	CXR7532B-L90	CXR7532B-L90N	CXR7532B-L90W	CXR7532B-T90	CXR7532B-X90
LEDs	SMD 2835					
Wattage	23W/45W	15W		20W	30W	
Lumen	1300lm/2700lm	900lm		1300lm	1800lm	
Dimension	600*88*34mm 1200*88*34mm	202*202*34mm		329*208.5*34mm	329*329*34mm	

**ORDERING INFORMATION:**

Example: CXR7532B/06/23W/840/ND

Model	Length	Lamp	CRI & CCT	Dimming
<b>CXR7532B</b>	<b>06</b>	<b>23W</b>	<b>840</b>	<b>ND</b>
CXR7532B	06 600mm 12 1200mm	23W 45W	840 Ra ≥ 80 4000K 856 Ra ≥ 80 5600K	ND Non Dim TD Triac Dim VD 0/1-10V Dim DD DALL Dim

Bari



**CXG1515C**

- Wattage** : Max 15W/m
- CRI** : Ra ≥ 80
- CCT** : 4000K / 6000K
- Lumen** : 1100lm/m
- Finish** : SW / SB / AA
- Material** : Extruded aluminum body and milky white PC
- Driver** : Constant voltage LED driver excluded

Cornering (Arc-shaped)

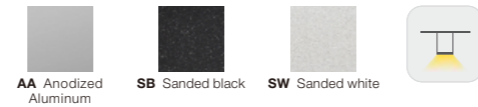
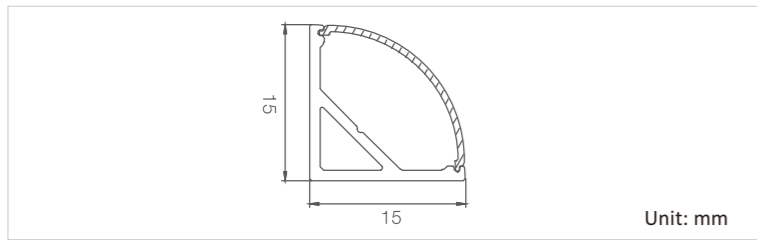

Flexible strip

Driver (to be ordered separately)



CEGB2835-50/A  
14W/m

Constant Voltage LED Driver  
CVD/80/24  
80W

Constant Voltage LED Driver  
CVD/150/24  
150W

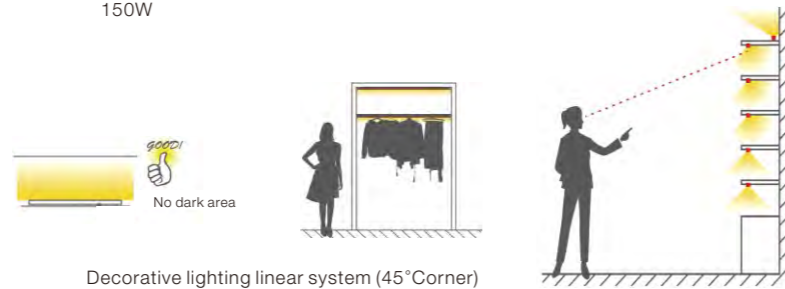

Decorative lighting linear system (45° Corner)

**ORDERING INFORMATION:** Constant voltage LED driver should be ordered separately.

**Example:** CXG1515C/05/14W/m/840

Model	Length	Lamp	CRI & CCT
CXG1515C	05	14W/m	840
CXG1515C	05 500mm	14W/m	840 Ra ≥ 80 4000K
	10 1000mm		860 Ra ≥ 80 6000K
	20 2000mm		

Pisa



**CXS3570B**

- Wattage** : 10W(0.6m) 20W(1.2m)
- CRI** : Ra ≥ 80
- CCT** : 4000K/5600K
- Lumen** : 750lm(0.6m) 1500lm(1.2m)
- Finish** : SW / SB / AA
- Material** : Extruded aluminum body and milky white PC
- Driver** : Built-in constant current LED driver



Pendant

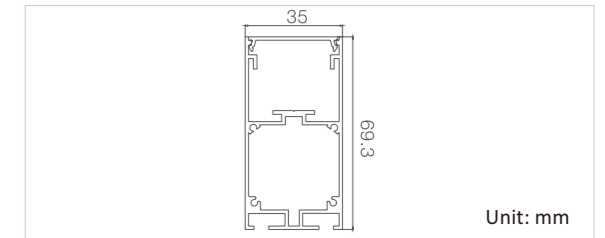
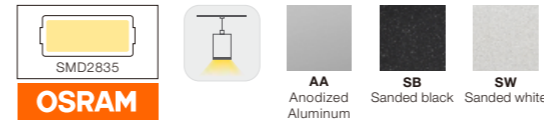

Accessories for connection (to be ordered separately)



"I" shape connector Flexible diffuser CEP3532B "L" shape connector L90

20W 4000K	h(m)	Ea(lx)	E(max)	D(cm)
1	1.85.6	559.9	261.31	
2	46.39	140.0	522.62	
3	20.62	62.21	783.92	
4	11.60	34.99	1045.2	
5	7.423	22.40	1306.5	

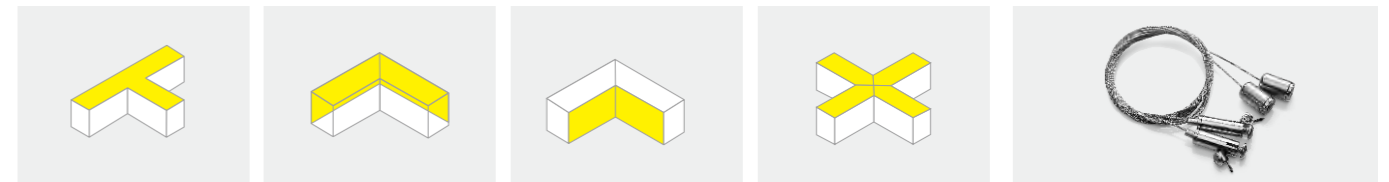

"T" shape connector T90 Outward 90° connector Inward 90° connector Cross shape connector X90 Pendant kits

Accessories (to be ordered separately)

Technical parameters

Type	Linear Profile	Accessories for connection				
Model	CXS3570B	CXS3570B-L90	CXS3570B-L90N	CXS3570B-L90W	CXS3570B-T90	CXS3570B-X90
LEDs	SMD 2835					
Wattage	10W/20W	5W		7W	9W	
Lumen	750lm/1500lm	370lm		520lm	670lm	
Dimension	600*35*69.3mm 1200*35*69.3mm	125*125*69.3mm		215*125*69.3mm	215*215*69.3mm	

**ORDERING INFORMATION:**

**Example:** CXS3570B/06/10W/840/ND

Model	Length	Lamp	CRI & CCT	Dimming
CXS3570B	06	10W	840	ND
CXS3570B	06 600mm	10W	840 Ra ≥ 80 4000K	ND Non Dim
	12 1200mm	20W	856 Ra ≥ 80 5600K	





### CXS5570B

**Wattage** : 15W(0.6m) 30W(1.2m)  
**CRI** : Ra ≥ 80  
**CCT** : 4000K/5600K  
**Lumen** : 900lm(0.6m) 1800lm(1.2m)  
**Finish** : SW / SB / AA  
**Material** : Extruded aluminum body and milky white PC  
**Driver** : Built-in constant current LED driver



#### Pendant

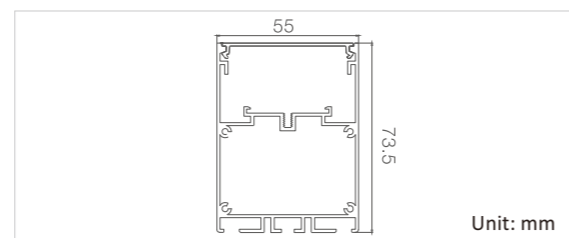
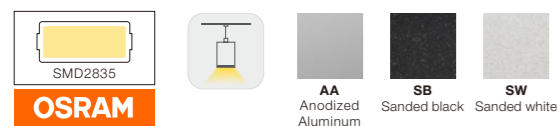

#### Accessories for connection (to be ordered separately)



30W 4000K	h(m)	Ea(lx)	E(max)	D(cm)
1	288.8	886.0	265.94	
2	72.20	221.5	531.88	
3	32.09	98.44	797.82	
4	18.05	55.37	1063.77	
5	11.55	35.44	1329.71	

"I" shape connector Flexible diffuser CEP5532B "L" shape connector L90

#### Accessories (to be ordered separately)

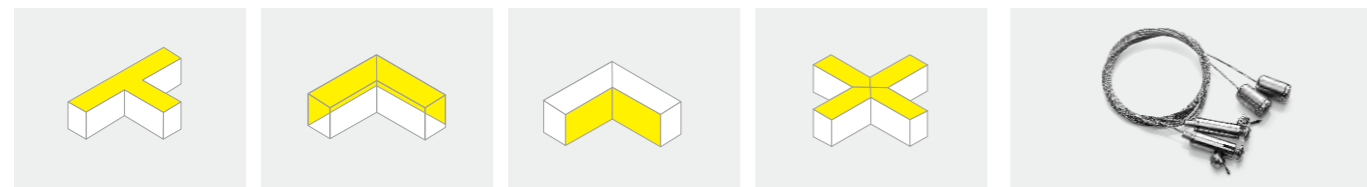

"T" shape connector T90 Outward 90° connector Inward 90° connector Cross shape connector X90 Pendant kits

#### Technical parameters

Type	Linear Profile	Accessories for connection				
Model	CXS5570B	CXS5570B-L90	CXS5570B-L90N	CXS5570B-L90W	CXS5570B-T90	CXS5570B-X90
LEDs	SMD 2835					
Wattage	15W/30W	7W		9W	12W	
Lumen	900lm/1800lm	420lm		550lm	750lm	
Dimension	600*55*73.5mm 1200*55*73.5mm	160*160*73.5mm		265*160*73.5mm	265*265*73.5mm	

### ORDERING INFORMATION:

**Example:** CXS5570B/06/15W/840/ND

Model	Length	Lamp	CRI & CCT	Dimming
CXS5570B	06	15W	840	ND
CXS5570B	06 600mm	15W	840 Ra ≥ 80 4000K	ND Non Dim
	12 1200mm	30W	856 Ra ≥ 80 5600K	



### CXS7570B

**Wattage** : 23W(0.6m) 45W(1.2m)  
**CRI** : Ra ≥ 80  
**CCT** : 4000K/5600K  
**Lumen** : 1300lm(0.6m) 2700lm(1.2m)  
**Finish** : SW / SB / AA  
**Material** : Extruded aluminum body and milky white PC  
**Driver** : Built-in constant current LED driver



#### Pendant

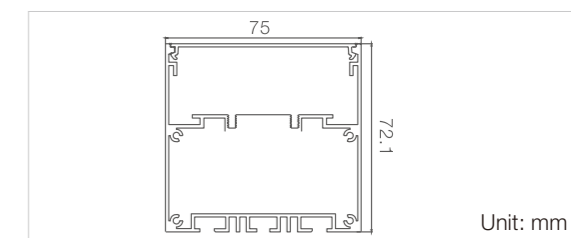
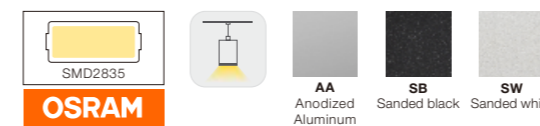

#### Accessories for connection (to be ordered separately)



45W 4000K	h(m)	Ea(lx)	E(max)	D(cm)
1	396.0	1263	275.43	
2	99.00	315.7	550.86	
3	44.00	140.3	826.28	
4	24.75	78.94	1101.71	
5	15.84	50.52	1377.14	

"I" shape connector Flexible diffuser CEP7532B "L" shape connector L90

#### Accessories (to be ordered separately)

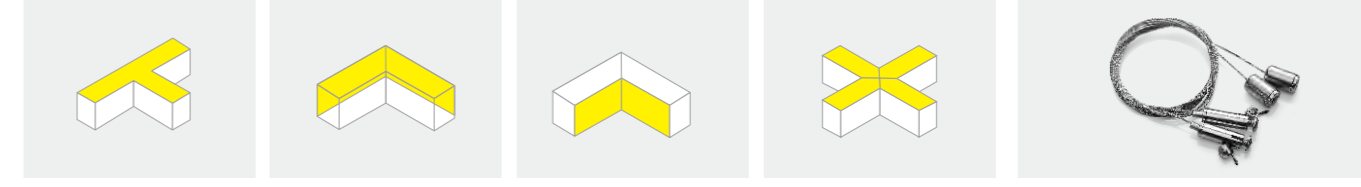

"T" shape connector T90 Outward 90° connector Inward 90° connector Cross shape connector X90 Pendant kits

#### Technical parameters

Type	Linear Profile	Accessories for connection				
Model	CXS7570B	CXS7570B-L90	CXS7570B-L90N	CXS7570B-L90W	CXS7570B-T90	CXS7570B-X90
LEDs	SMD 2835					
Wattage	23W/45W	15W		20W	30W	
Lumen	1300lm/2700lm	900lm		1300lm	1800lm	
Dimension	600*75*72.1mm 1200*75*72.1mm	202*202*72.1mm		329*202*72.1mm	329*329*72.1mm	

### ORDERING INFORMATION:

**Example:** CXS7570B/06/23W/840/ND

Model	Length	Lamp	CRI & CCT	Dimming
CXS7570B	06	23W	840	ND
CXS7570B	06 600mm	23W	840 Ra ≥ 80 4000K	ND Non Dim
	12 1200mm	45W	856 Ra ≥ 80 5600K	

Bern



**CXS9090B**

- Wattage** : 36W(1.2m) 72W(2.4m)
- CRI** : Ra ≥ 80
- CCT** : 3000K/4000K/6400K
- Lumen** : 3000lm(1.2m) 6000lm(2.4m)
- Finish** : Matte white
- Material** : Extruded aluminum body and milky white PC
- Driver** : Constant current LED driver

Pendant anchor rod

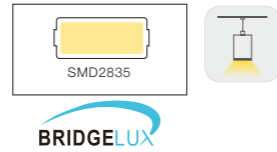
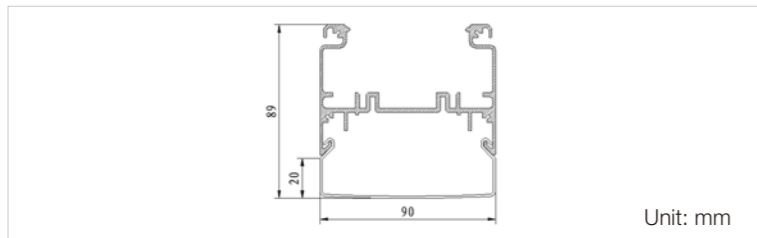

Accessories



Mounting Clips

Connection



36W 4000K	Beam Angle	h(m)	Ea(lx)	E(max)	D(cm)
	1	310.4	1122	332.78	
	2	77.60	280.41	665.57	
	3	34.49	124.61	998.35	
	4	19.40	70.11	1331.13	
	5	12.42	44.87	1663.91	

**ORDERING INFORMATION:**

Example: CXS9090B/12/36W/830/ND

Model	Length	Wattage	CRI & CCT	Dimming
CXS9090B	12	36W	830	ND
CXS9090B	12 1200mm	36W	830 Ra≥80 3000K	ND Non Dim
	24 2400mm	72W	840 Ra≥80 4000K	
			864 Ra≥80 6400K	

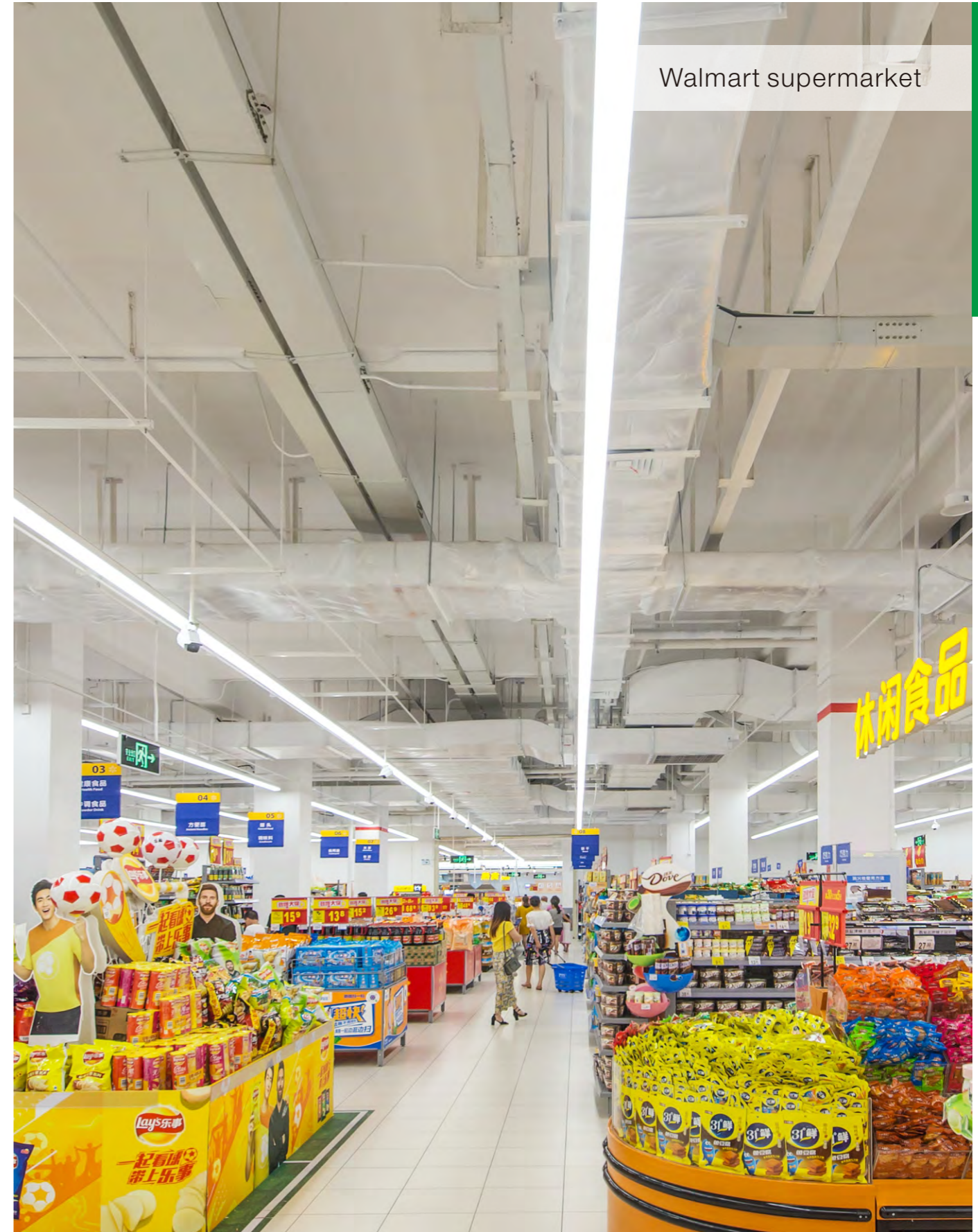

Walmart supermarket

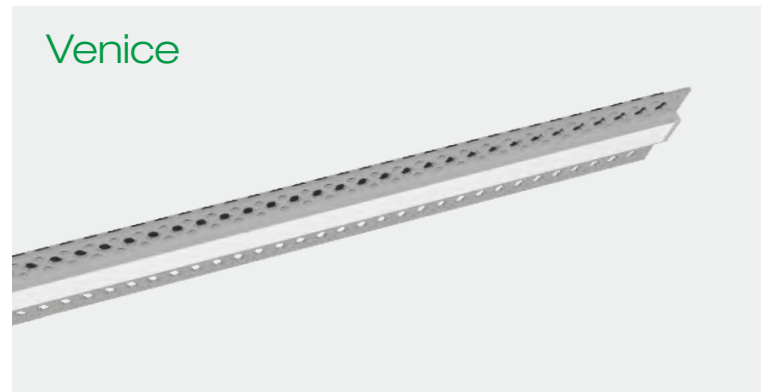

**CXR1715BW**  
**Wattage** : Max 15W/m  
**CRI** : Ra ≥ 80  
**CCT** : 4000K / 6000K  
**Lumen** : 1100lm/m  
**Finish** : SW / SB / AA  
**Material** : Extruded aluminum body and milky white PC  
**Driver** : Constant voltage LED driver excluded

Recessed trimless

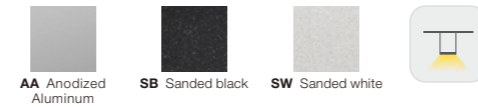
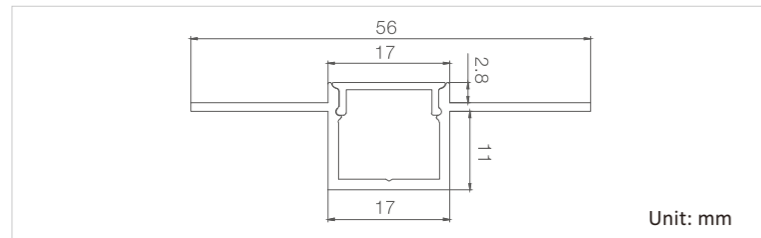

Flexible strip



CEGB2835-50/A  
14W/m

Flexible diffuser  
CEP1715B

Driver (to be ordered separately)



Constant Voltage LED Driver  
CVD/80/24  
80W

Constant Voltage LED Driver  
CVD/150/24  
150W

**ORDERING INFORMATION:** Constant voltage LED driver should be ordered separately.

**Example:** CXR1715BW/05/14W/m/840

Model	Length	Lamp	CRI & CCT
<b>CXR1715BW</b>	<b>05</b>	<b>14W/m</b>	<b>840</b>
CXR1715BW	05 500mm	14W/m CEGB2835-50/A	840 Ra ≥ 80 4000K
	10 1000mm		860 Ra ≥ 80 6000K
	20 2000mm		



**CXR1715N**  
**Wattage** : Max 15W/m  
**CRI** : Ra ≥ 80  
**CCT** : 4000K / 6000K  
**Lumen** : 1100lm/m  
**Finish** : SW / SB / AA  
**Material** : Extruded aluminum body and milky white PC  
**Driver** : Constant voltage LED driver excluded

Recessed (Inner corner)

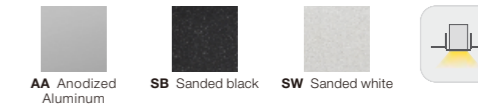
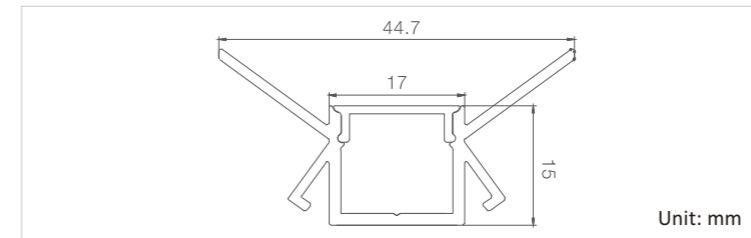

Flexible strip



CEGB2835-50/A  
14W/m

Flexible diffuser  
CEP1715B

Driver (to be ordered separately)



Constant Voltage LED Driver  
CVD/80/24  
80W

Constant Voltage LED Driver  
CVD/150/24  
150W

**ORDERING INFORMATION:** Constant voltage LED driver should be ordered separately.

**Example:** CXR1715N/05/14W/m/830

Model	Length	Lamp	CRI & CCT
<b>CXR1715N</b>	<b>05</b>	<b>14W/m</b>	<b>830</b>
CXR1715N	05 500mm	14W/m CEGB2835-50/A	830 Ra ≥ 80 3000K
	10 1000mm		840 Ra ≥ 80 4000K
	20 2000mm		860 Ra ≥ 80 6000K

Venice

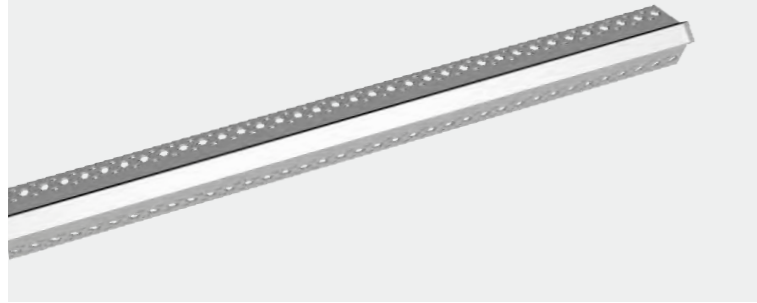

**CXR1715W**

- Wattage** : Max 15W/m
- CRI** : Ra ≥ 80
- CCT** : 4000K / 6000K
- Lumen** : 1100lm/m
- Finish** : SW / SB / AA
- Material** : Extruded aluminum body and milky white PC
- Driver** : Constant voltage LED driver excluded

Recessed(External corner)

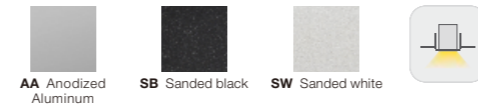
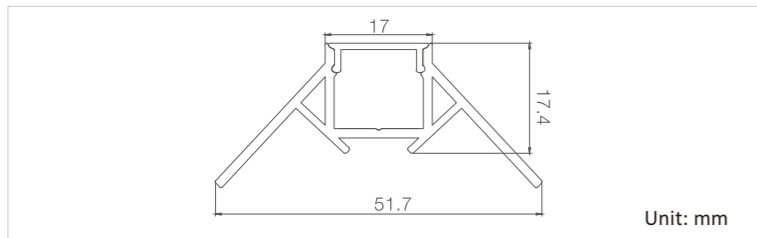

Flexible strip



CEGB2835-50/A  
14W/m



Flexible diffuser  
CEP1715B

Driver (to be ordered separately)



Constant Voltage LED Driver  
CVD/80/24  
80W



Constant Voltage LED Driver  
CVD/150/24  
150W

**ORDERING INFORMATION:** Constant voltage LED driver should be ordered separately.

**Example:** CXR1715W/05/14W/m/840

Model	Length	Lamp	CRI & CCT
CXR1715W	05	14W/m	840
CXR1715W	05 500mm	14W/m	840 Ra ≥ 80 4000K
	10 1000mm		860 Ra ≥ 80 6000K
	20 2000mm		



Yeosu



Seamless connection by flexible PC diffuser 10 m/roll

### Features:

- Two kinds of Installation: pendant or track-mounted
- Various connection accessories: "T" type, "+" type, "L" type and "-" type
- The standard length is 1.2m(other length needs to customize)
- Well-distributed light spot and UGR < 19

Yeosu



Pendant Linear Profile

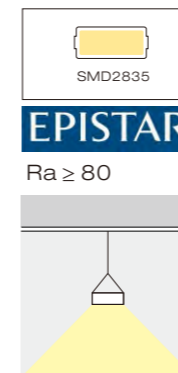

Downward Light CEP6575P

h(m)	d(cm)	Em	Emax
1.00	185.93	681.0	1318
2.00	371.86	170.2	329.4
3.00	557.79	75.66	146.4
4.00	743.72	42.56	82.35
5.00	929.64	27.24	52.70

### CEB6575P

- Wattage** : 28W
- CRI** : Ra ≥ 80
- CCT** : 2700K / 3000K / 4000K
- Beam** : 110°
- Length** : 1200mm
- Luminous Flux** : 2800~3000lm
- Finish** : Silver grey body and white diffuser
- Material** : Extruded alu. body and PC diffuser
- Driver** : 700mA constant current built-in LED driver included

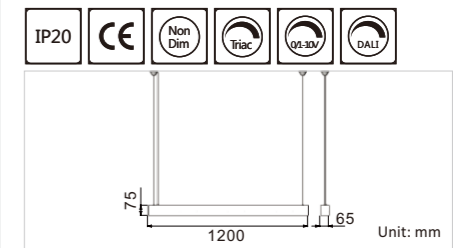

Downward Light CEP6575P or Up+Downward Light CEP6575PH is optional.

### ORDERING INFORMATION: Other length to customize

**Example:** CEB6575P/12/28W/827

Model	Length	Wattage	CRI & CCT
CEB6575P	12	28W	827
CEB6575P	12 1200mm	28W	827 Ra ≥ 80 2700K 830 Ra ≥ 80 3000K 840 Ra ≥ 80 4000K

## Jindo



### CEB2212B-B

- Wattage** : 36W
- CRI** : Ra ≥ 80
- CCT** : 4000K / 6000K
- Beam** : 110°
- Length** : 1200mm
- Luminous Flux** : 2300~2500lm
- Finish** : Silver grey body and white diffuser
- Material** : Extruded aluminum body and PC diffuser
- Driver** : Constant current built-in LED driver included

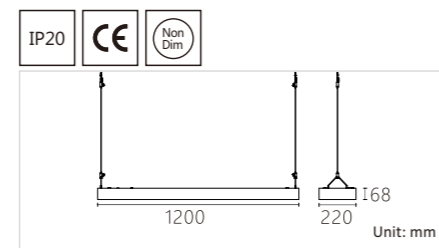

Pendant Linear Profile

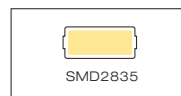

**EPISTAR**

Ra ≥ 80

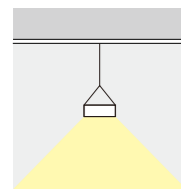

h(m)	D(cm)	E(max)
1.0	259.90	273.4
2.0	519.79	68.34
3.0	779.69	30.37
4.0	1039.58	17.08
5.0	1299.48	10.93

## Seoul



### CEB0712F-B / CEB1012F-B

- Wattage** : 30W
- CRI** : Ra ≥ 80
- CCT** : 4000K / 6000K
- Beam** : 110°
- Length** : 1200mm
- Luminous Flux** : 2300~2500lm
- Finish** : Matt white body and white diffuser
- Material** : Extruded aluminum body and PMMA diffuser
- Driver** : 700mA constant current remote LED driver include

Suitable for 5-20mm thick ceiling board

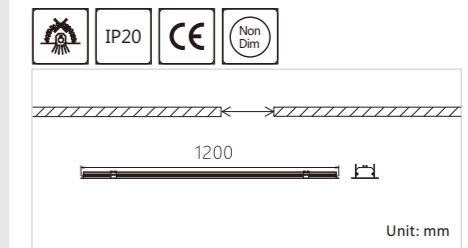

Recessed Linear Profile

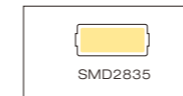

**EPISTAR**

Ra ≥ 80

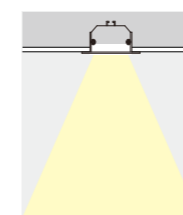

h(m)	D(cm)	E(max)
1.0	252.93	296.9
2.0	505.86	74.23
3.0	758.79	32.99
4.0	1011.72	18.56
5.0	1264.65	11.88

### Different dimension of two products

Model	Dimension (mm)	Cut-out (mm)
CEB0712F-B	1200x64x30	1190x50
CEB1012F-B	1200x95x40	1190x85

### ORDERING INFORMATION:

**Example:** CEB2212B-B/12/36W/840

Model	Length	Wattage	CRI & CCT
CEB2212B-B	12	36W	840
CEB2212B-B	12 1200mm	36W	840 Ra ≥ 80 4000K 860 Ra ≥ 80 6000K

### ORDERING INFORMATION:

**Example:** CEB0712F-B/12/30W/840

Model	Length	Wattage	CRI & CCT
CEB0712F-B	12	30W	827
CEB0712F-B	12 1200mm	30W	840 Ra ≥ 80 4000K 860 Ra ≥ 80 6000K

# Milan

## Shaped Linear

1、 Compact aluminum linear lighting with section size of W35\*H28mm, along with flexible anti-leakage diffuser. It comes with shape of downwards lighting, inwards lighting, outwards lighting and seamless connection can be achieved between each two shapes, so that 3D stereoscopic lighting effect can be achieved .





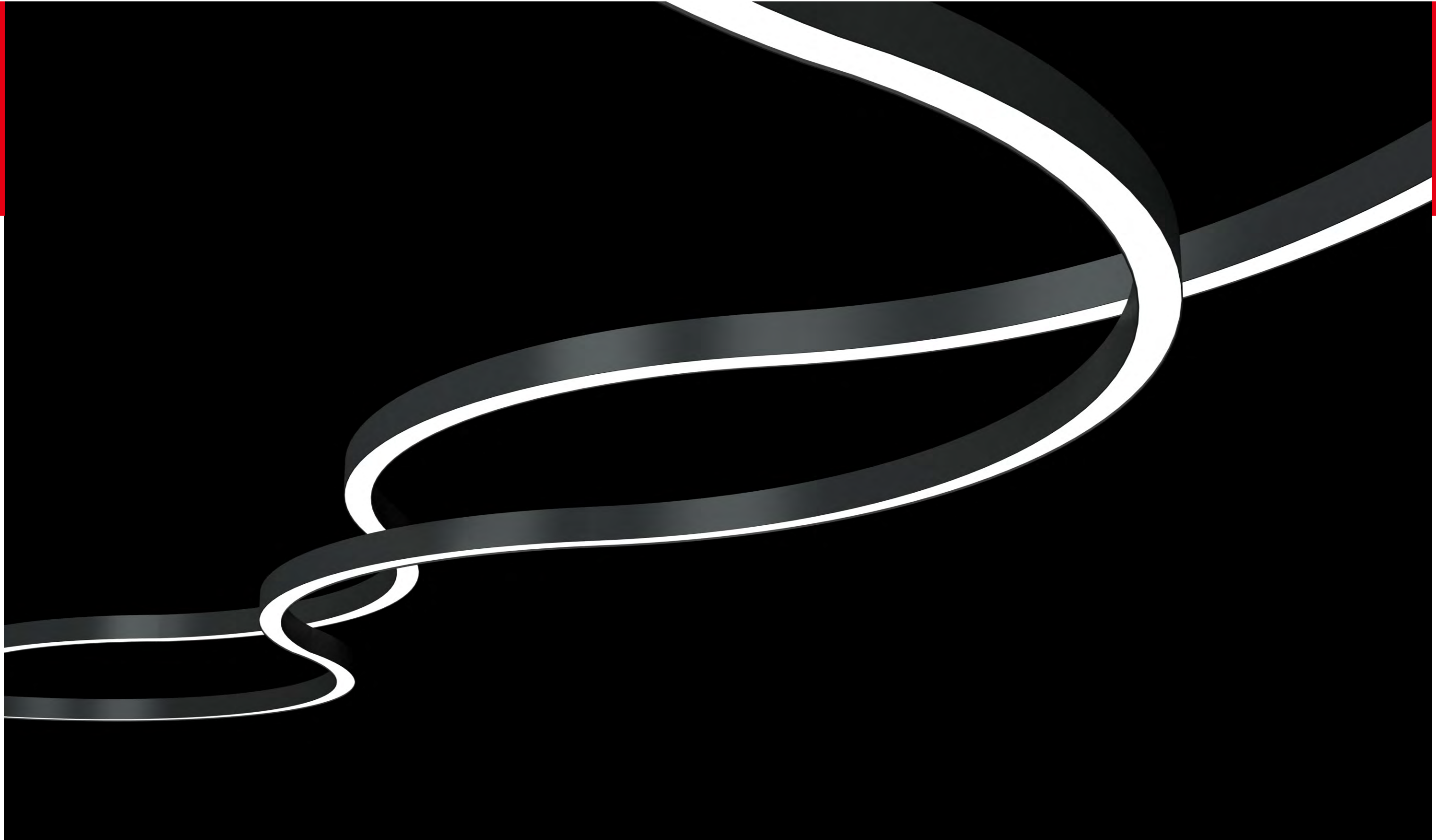



2、 Compact aluminum linear lighting utilize the industry-leading bending technology and minimum circular diameter of 500mm can be achieved. Same flexible diffuser can be bended for outwards lighting, inwards lighting, downwards lighting application.















## Linear LED Lighting Solutions

	Shaped Linear				
Model	 CXS3528B-12	 CXS3528B-D10A45	 CXS3528B-D10N45	 CXS3528B-D10W45	 CXS3528B-D10A90
Type	Downwards emitting	Downwards emitting	Inwards emitting	Outwards emitting	Downwards emitting
Wattage	24W	8W		16W	
CRI	Ra≥80				
CCT	3000K / 4000K / 6000K				
Beam	110°				
Luminous Flux	1000lm	320lm		650lm	
Finish	Matt silver grey / Sanded white / Sanded black				
Material	Extruded aluminum and Silicone Diffuser				
Mounting accessories excluded	 Pendant kit CXS3528B-DXB				
Constant Voltage LED Driver (DC 24V)	 CVD/80/24 80W		 CVD/150/24 150W		

	Shaped Linear				
Model	 CXS3528B-D10N90	 CXS3528B-D10W90	 CXS3528B-D10A00	 CXS3528B-D10N00	 CXS3528B-D10W00
Type	Inwards emitting	Outwards emitting	Downwards emitting	Inwards emitting	Outwards emitting
Wattage	16W		64W		
CRI	Ra≥80				
CCT	3000K / 4000K / 6000K				
Beam	110°				
Luminous Flux	650lm		2700lm		
Finish	Matt silver grey / Sanded white / Sanded black				
Material	Extruded aluminum and Silicone Diffuser				
Mounting accessories excluded	 Pendant kit CXS3528B-DXB				
Constant Voltage LED Driver (DC 24V)	 CVD/80/24 80W		 CVD/150/24 150W		

**Product Feature**

Bend diameter= 1000mm ( Standard )  
 Minimum diameter 500mm can be customized

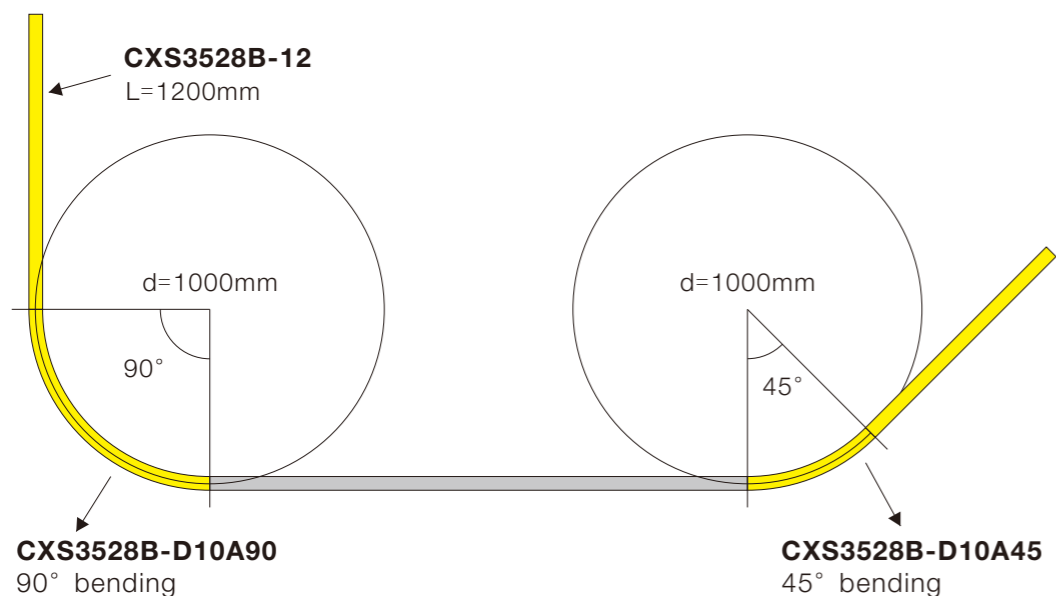

The usual length of this flexible diffuser can be 20 meters max.  
 The other length, which is more than 20 meters also can be customized, but max. length is 100 meters.

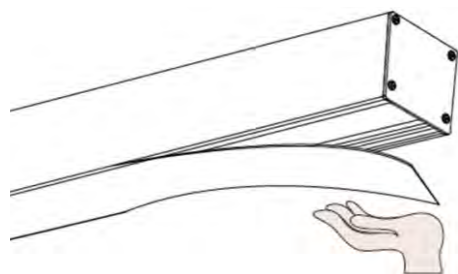

Flexible diffuser

Notes:  
 This flexible diffuser usually is cut by installer at site according to the exact length required. Considering the expansion and contraction because of temperature changes, please reserve a suitable length before cutting.

There are three types of emitting way.

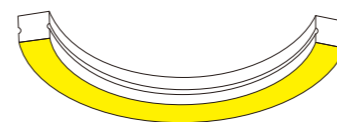

Downwards emitting

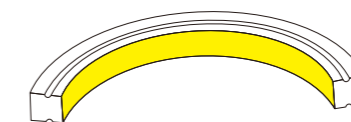

Inwards emitting



Outwards emitting

Two standard order options

**Straight shape**  
 CXS3528B

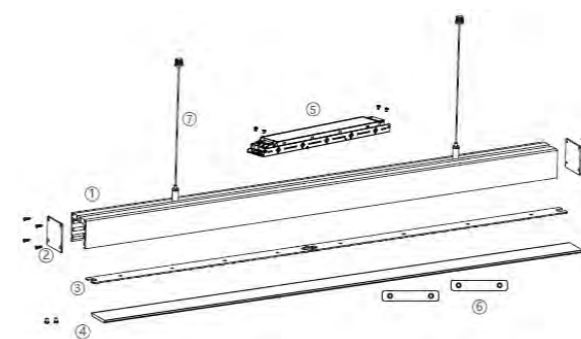

- ① Profile
- ④ Flexible diffuser
- ⑦ Pendant kit

**Curved shape**

CXS3528B-D10A90 / CXS3528B-D10A45

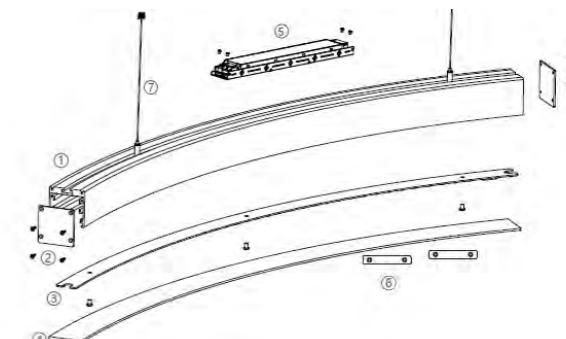

- ② End cap
- ⑤ Constant voltage LED driver
- ③ Printed circuit Board
- ⑥ "I" shape connector

The constant voltage LED driver, which is compatible with XH3528 profile series should be ordered separately. Please consult the sales manager for advice, according to the site request.

Two installation options

**Surface mounted**

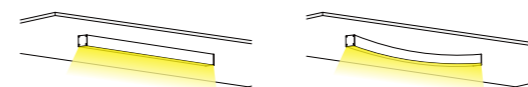

**Pendant**

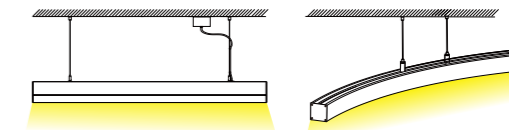

**Notes:** Installation kits to be ordered separately

# Milan



- Indoor use
- General lighting
- Low energy consumption
- Anti-glare
- Precise light distribution
- Flicker-free
- Long life

## Milan



### CXS3528B-12

- Wattage** : 24W
- CRI** : Ra ≥ 80
- CCT** : 3000K/4000K/6000K
- Beam** : 110°
- Lumen** : 1100lm
- Finish** : Matt silver grey/Sanded white/Sanded black
- Material** : Extruded aluminum body and Silicone diffuser
- Driver** : DC 24V constant voltage remote LED driver excluded

Surface mounted / Pendant

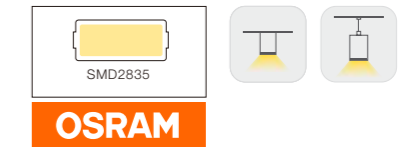
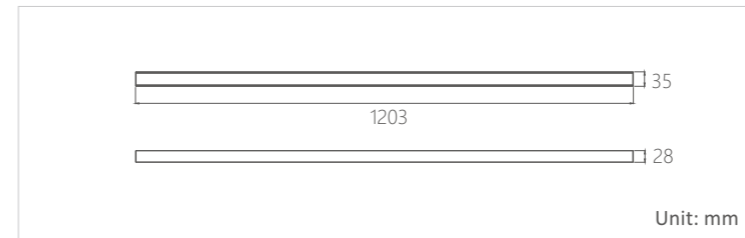

### Accessories ( to be ordered separately )



Surface-mounted kits  
CXS3528B-MZB



Pendant kit  
CXS3528B-DXB



Flexible diffuser  
CEP3528B



Constant Voltage LED Driver  
(DC 24V)  
CVD/80/24  
80W



Constant Voltage LED Driver  
(DC 24V)  
CVD/150/24  
150W

#### Notes:

A lot of accessories should be ordered, according to the site condition. Please consult your sales manager, based on specific project request.

h(m)	Ea(lx)	E(max)	D(cm)
1	111.9	376.2	295.12
2	27.97	94.05	590.24
3	12.43	41.80	885.35
4	6.992	23.51	1180.47
5	4.475	15.05	1475.59

Beam Angle 110° 24W 4000K

### ORDERING INFORMATION:

Example: CXS3528B/12/24W/830/ND

Model	Length	Wattage	CRI & CCT	Dimming
CXS3528B	12	24W	830	ND
CXS3528B	L=1203mm	24W	830 Ra≥80 3000K 840 Ra≥80 4000K 860 Ra≥80 6000K	ND Non Dim TD Triac Dim VD 0/1-10V Dim DD DALL Dim



### CXS3528-D10A45

- Wattage** : 8W
- CRI** : Ra ≥ 80
- CCT** : 3000K/4000K/6000K
- Beam** : 110°
- Lumen** : 320lm
- Finish** : Matt silver grey/Sanded white/Sanded black
- Material** : Extruded aluminum body and Silicone diffuser
- Driver** : DC 24V constant voltage remote LED driver excluded

Surface mounted / Pendant

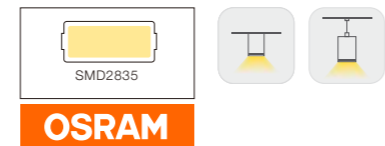
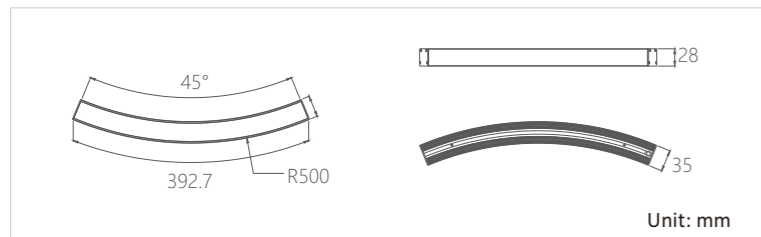

#### Accessories ( to be ordered separately )



**Notes:**  
A lot of accessories should be ordered, according to the site condition. Please consult your sales manager, based on specific project request.

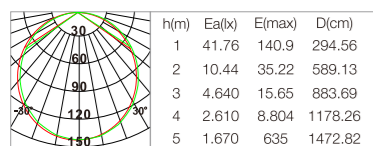

Beam Angle 110° 8W 4000K

### ORDERING INFORMATION:

**Example:** CXS3528-D10A45/8W/830/ND

Model	Diameter	Type	Bending	Wattage	CRI & CCT	Dimming
CXS3528	D10	A	45	8W	830	ND
CXS3528	D=1000mm	Downwards emitting	45 45°	8W	830 Ra≥80 3000K 840 Ra≥80 4000K 860 Ra≥80 6000K	ND Non Dim TD Triac Dim VD 0/1-10V Dim DD DALL Dim



### CXS3528B-D10A90

- Wattage** : 16W
- CRI** : Ra ≥ 80
- CCT** : 3000K/4000K/6000K
- Beam** : 110°
- Lumen** : 650lm
- Finish** : Matt silver grey/Sanded white/Sanded black
- Material** : Extruded aluminum body and Silicone diffuser
- Driver** : DC 24V constant voltage remote LED driver excluded

Surface mounted / Pendant

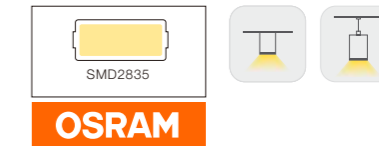
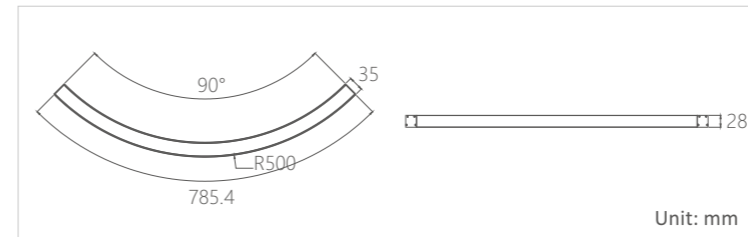

#### Accessories ( to be ordered separately )



**Notes:**  
A lot of accessories should be ordered, according to the site condition. Please consult your sales manager, based on specific project request.

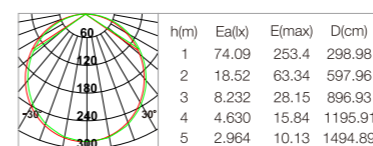

Beam Angle 110° 16W 4000K

### ORDERING INFORMATION:

**Example:** CXS3528B-D10A90/16W/830/ND

Model	Length	Type	Category	Wattage	CRI & CCT	Dimming
CXS3528B	D10	A	90	16W	830	ND
CXS3528B	D=1000mm	Downwards emitting	90 90°	16W	830 Ra≥80 3000K 840 Ra≥80 4000K 860 Ra≥80 6000K	ND Non Dim TD Triac Dim VD 0/1-10V Dim DD DALL Dim



Surface mounted / Pendant

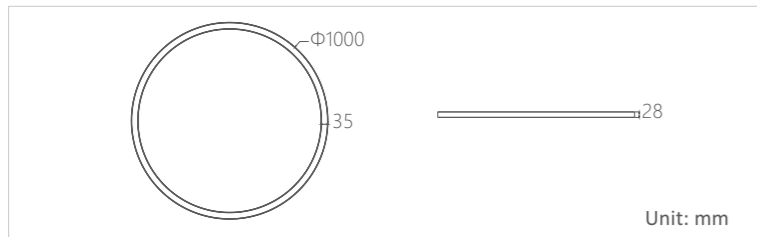

**CXS3528B-D10A00**

- Wattage** : 64W
- CRI** : Ra ≥ 80
- CCT** : 2700K/3000K/4000K/6000K
- Beam** : 110°
- Lumen** : 2700lm
- Finish** : Matt silver grey/Sanded white/Sanded black
- Material** : Extruded aluminum body and Silicone diffuser
- Driver** : DC 24V constant voltage remote LED driver excluded

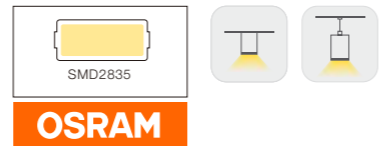

Accessories ( to be ordered separately )



**Notes:**  
A lot of accessories should be ordered, according to the site condition.  
Please consult your sales manager, based on specific project request.

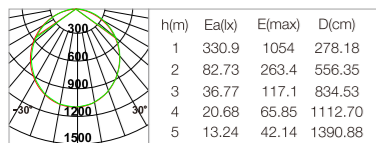

**ORDERING INFORMATION:**

**Example:** CXS3528B-D10A00/64W/830/ND

Model	Length	Type	Category	Wattage	CRI & CCT	Dimming
CXS3528B	D10	A	00	64W	830	ND
CXS3528B	D=1000mm	Downwards emitting	00 Round	64W	830 Ra≥80 3000K 840 Ra≥80 4000K 860 Ra≥80 6000K	ND Non Dim TD Triac Dim VD 0/1-10V Dim DD DALL Dim



Surface mounted / Pendant

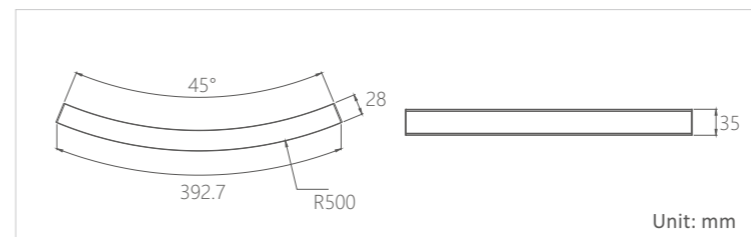

**CXS3528B-D10N45**

- Wattage** : 8W
- CRI** : Ra ≥ 80
- CCT** : 3000K/4000K/6000K
- Beam** : 110°
- Lumen** : 320lm
- Finish** : Matt silver grey/Sanded white/Sanded black
- Material** : Extruded aluminum body and Silicone diffuser
- Driver** : DC 24V constant voltage remote LED driver excluded

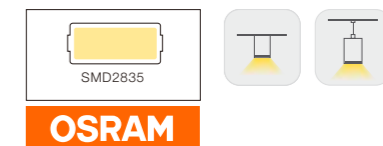

Accessories ( to be ordered separately )



**Notes:**  
A lot of accessories should be ordered, according to the site condition.  
Please consult your sales manager, based on specific project request.

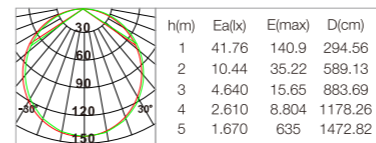

**ORDERING INFORMATION:**

**Example:** CXS3528B-D10N45/8W/830/ND

Model	Length	Type	Category	Wattage	CRI & CCT	Dimming
CXS3528B	D10	N	45	8W	830	ND
CXS3528B	D=1000mm	Downwards emitting	90 90°	16W	830 Ra≥80 3000K 840 Ra≥80 4000K 860 Ra≥80 6000K	ND Non Dim TD Triac Dim VD 0/1-10V Dim DD DALL Dim



### CXS3528B-D10N90

- Wattage** : 16W
- CRI** : Ra ≥ 80
- CCT** : 3000K/4000K/6000K
- Beam** : 110°
- Lumen** : 650lm
- Finish** : Matt silver grey/Sanded white/Sanded black
- Material** : Extruded aluminum body and Silicone diffuser
- Driver** : DC 24V constant voltage remote LED driver excluded

Surface mounted / Pendant

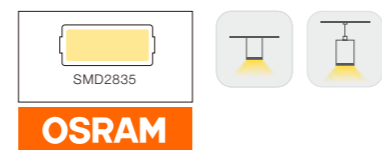
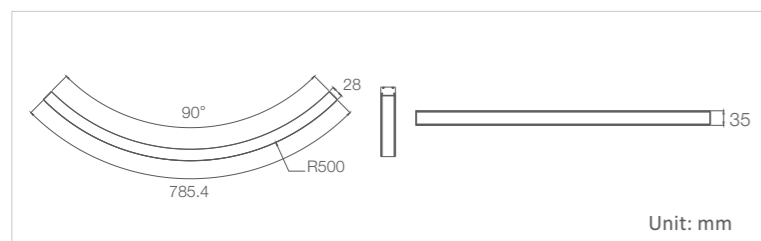

#### Accessories ( to be ordered separately )



**Notes:**  
A lot of accessories should be ordered, according to the site condition.  
Please consult your sales manager, based on specific project request.

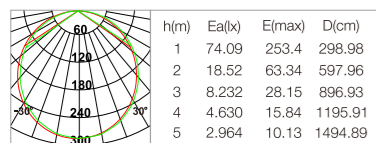

Beam Angle 110° 16W 4000K

### ORDERING INFORMATION:

**Example:** CXS3528B-D10N90/16W/830/ND

Model	Length	Type	Category	Wattage	CRI & CCT	Dimming
CXS3528B	D10	N	90	16W	830	ND
CXS3528B	D=1000mm	Inwards emitting	90 90°	16W	830 Ra≥80 3000K 840 Ra≥80 4000K 860 Ra≥80 6000K	ND Non Dim TD Triac Dim VD 0/1-10V Dim DD DALL Dim



### CXS3528B-D10N00

- Wattage** : 64W
- CRI** : Ra ≥ 80
- CCT** : 3000K/4000K/6000K
- Beam** : 110°
- Lumen** : 2700lm
- Finish** : Matt silver grey/Sanded white/Sanded black
- Material** : Extruded aluminum body and Silicone diffuser
- Driver** : DC 24V constant voltage remote LED driver excluded

Surface mounted / Pendant

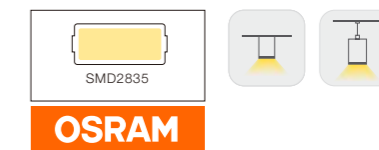
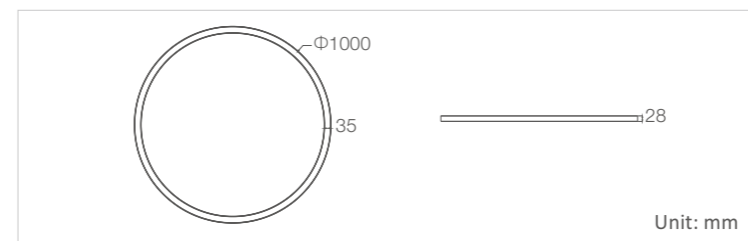

#### Accessories ( to be ordered separately )



**Notes:**  
A lot of accessories should be ordered, according to the site condition.  
Please consult your sales manager, based on specific project request.

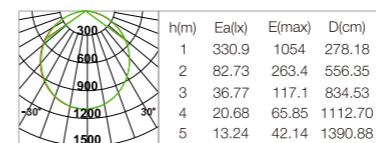

Beam Angle 110° 64W 4000K

### ORDERING INFORMATION:

**Example:** CXS3528B-D10N00/64W/830/ND

Model	Length	Type	Category	Wattage	CRI & CCT	Dimming
CXS3528B	D10	N	00	64W	830	ND
CXS3528B	D=1000mm	Inwards emitting	00 Round	64W	830 Ra≥80 3000K 840 Ra≥80 4000K 860 Ra≥80 6000K	ND Non Dim TD Triac Dim VD 0/1-10V Dim DD DALL Dim



### CXS3528B-D10W45

- Wattage** : 8W
- CRI** : Ra ≥ 80
- CCT** : 3000K/4000K/6000K
- Beam** : 110°
- Lumen** : 320lm
- Finish** : Matt silver grey/Sanded white/Sanded black
- Material** : Extruded aluminum body and Silicone diffuser
- Driver** : DC 24V constant voltage remote LED driver excluded

Surface mounted / Pendant

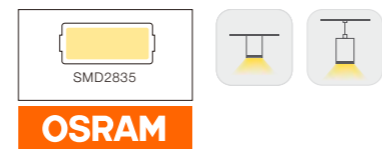
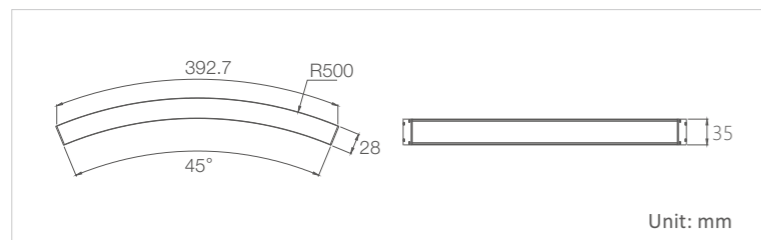

#### Accessories ( to be ordered separately )



**Notes:**  
A lot of accessories should be ordered, according to the site condition.  
Please consult your sales manager, based on specific project request.

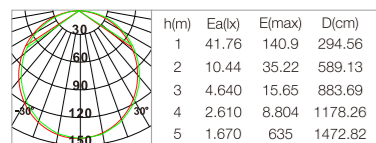

Beam Angle 110° 8W 4000K

### ORDERING INFORMATION:

**Example:** CXS3528B-D10W45/8W/830/ND

Model	Length	Type	Category	Wattage	CRI & CCT	Dimming
CXS3528B	D10	W	45	8W	830	ND
CXS3528B	D=1000mm	Outwards emitting	45 45°	8W	830 Ra≥80 3000K 840 Ra≥80 4000K 860 Ra≥80 6000K	ND Non Dim TD Triac Dim VD 0/1-10V Dim DD DALL Dim



### CXS3528B-D10W90

- Wattage** : 16W
- CRI** : Ra ≥ 80
- CCT** : 3000K/4000K/6000K
- Beam** : 110°
- Lumen** : 750lm
- Finish** : Matt silver grey/Sanded white/Sanded black
- Material** : Extruded aluminum body and Silicone diffuser
- Driver** : DC 24V constant voltage remote LED driver excluded

Surface mounted / Pendant

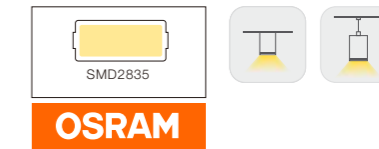
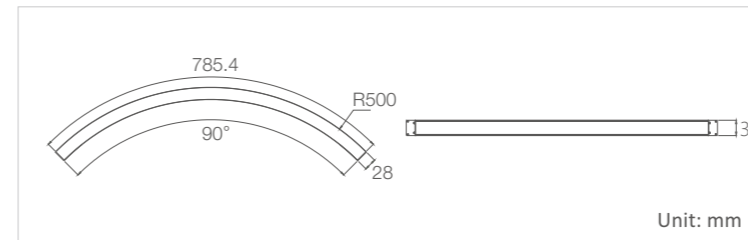

#### Accessories ( to be ordered separately )



**Notes:**  
A lot of accessories should be ordered, according to the site condition.  
Please consult your sales manager, based on specific project request.

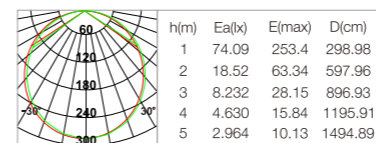

Beam Angle 110° 16W 4000K

### ORDERING INFORMATION:

**Example:** CXS3528B-D10W90/16W/830/ND

Model	Length	Type	Category	Wattage	CRI & CCT	Dimming
CXS3528B	D10	W	90	16W	830	ND
CXS3528B	D=1000mm	Outwards emitting	90 90°	16W	830 Ra≥80 3000K 840 Ra≥80 4000K 860 Ra≥80 6000K	ND Non Dim TD Triac Dim VD 0/1-10V Dim DD DALL Dim

## Milan

**CXS3528B-D10W00**

**Wattage** : 64W  
**CRI** : Ra ≥ 80  
**CCT** : 3000K/4000K/6000K  
**Beam** : 110°  
**Lumen** : 2700lm  
**Finish** : Matt silver grey/Sanded white/Sanded black  
**Material** : Extruded aluminum body and Silicone diffuser  
**Driver** : DC 24V constant voltage remote LED driver excluded

Surface mounted / Pendant

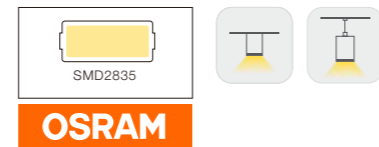
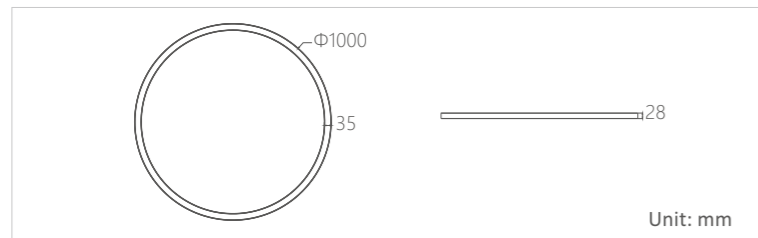

## Accessories ( to be ordered separately )

Surface-mounted kits  
CXS3528B-MZBPendant kit  
CXS3528B-DXBFlexible diffuser  
CEP3528BConstant Voltage LED Driver  
(DC 24V)  
CVD/80/24  
80WConstant Voltage LED Driver  
(DC 24V)  
CVD/150/24  
150W**Notes:**

A lot of accessories should be ordered, according to the site condition.  
Please consult your sales manager, based on specific project request.

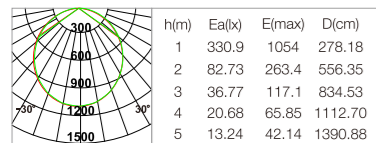

Beam Angle 110° 64W 4000K

**ORDERING INFORMATION:****Example:** CXS3528B-D10W00/64W/830/ND

Model	Length	Type	Category	Wattage	CRI & CCT	Dimming
CXS3528B	D10	W	00	64W	830	ND
CXS3528B	D=1000mm	Outwards emitting	00 Round	64W	830 Ra≥80 3000K 840 Ra≥80 4000K 860 Ra≥80 6000K	ND Non Dim TD Triac Dim VD 0/1-10V Dim DD DALL Dim

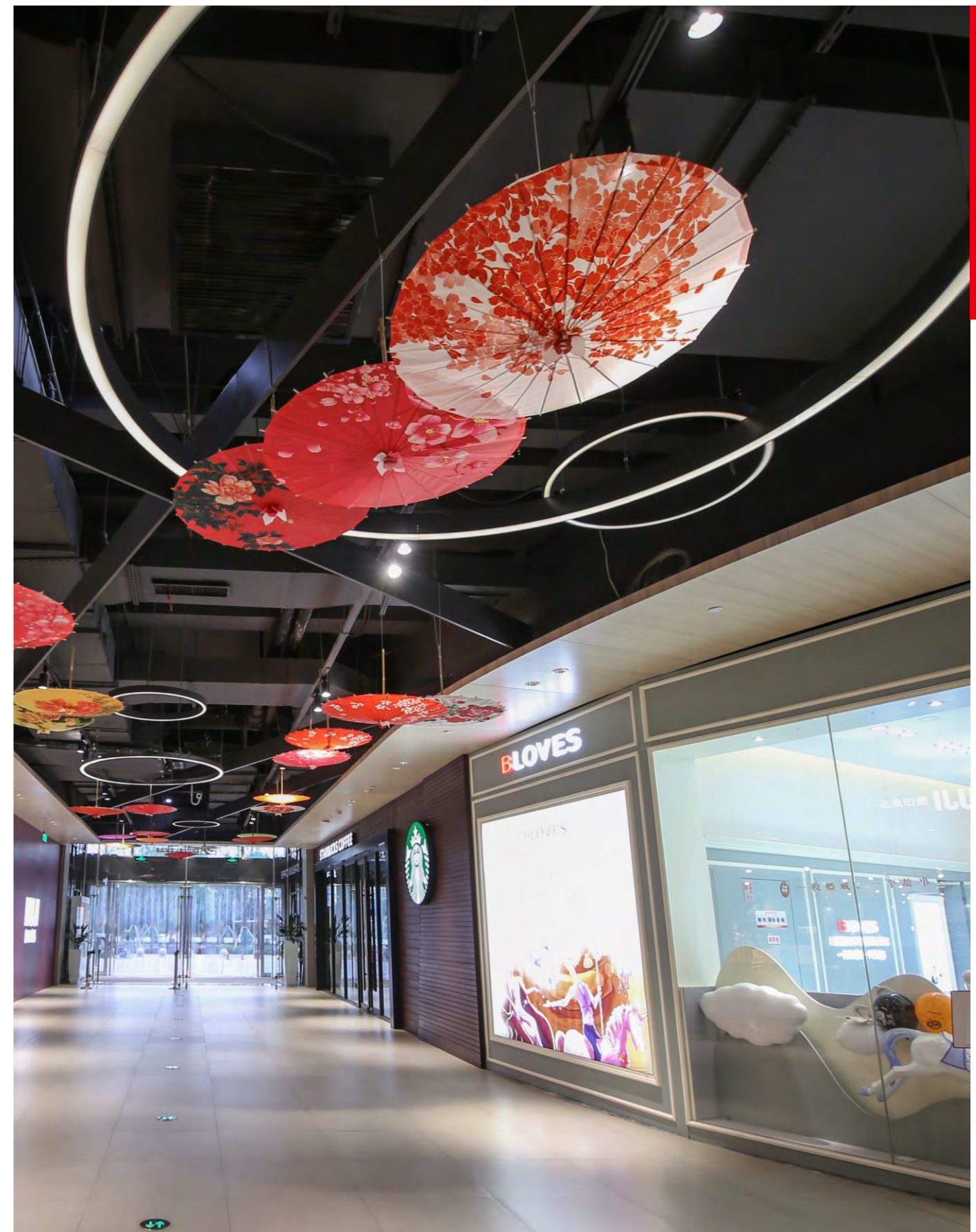



## Osaka series

1. Unique honeycomb design to reach UGR<19.
2. Specially designed end cap with honeycomb to make people enjoy soft light in more direction.
3. Linear connection can be achieved.



# Office Lighting

Model	 CXS75105G	 CXS7545G	 CEB3008T-D
LEDs	LED SMD 2835		
Wattage	36W	30W	60W
CRI	Ra≥80		
CCT	3000K/4000K/6000K		
Luminous Flux	2500lm	2200lm	3500lm
Finish	White or black body and white honeycomb		White body prismatic PMMA
Dimension	75*105*1380mm	74*45*1357mm	800*320*1940mm
Material	Extruded aluminum body and PC		Extruded aluminum body and PMMA
Driver	Built-in constant current LED driver		



**CXS75105G**  
**Wattage** : 36W  
**CRI** : Ra ≥ 80  
**CCT** : 3000K / 4000K / 6000K  
**Beam** : 110°  
**Lumen** : 2500lm  
**Finish** : BK / DW  
**Material** : Extruded aluminum body and PC  
**Pendant wire:**  
**1.5 meters long as standard**

Pendant

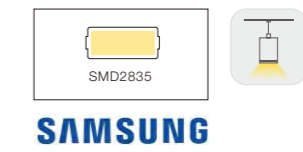
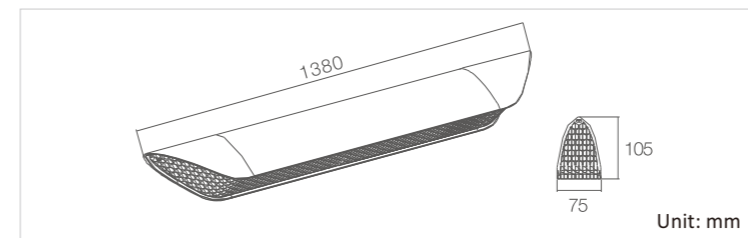
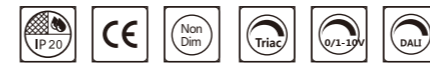

Linear connection can be achieved.

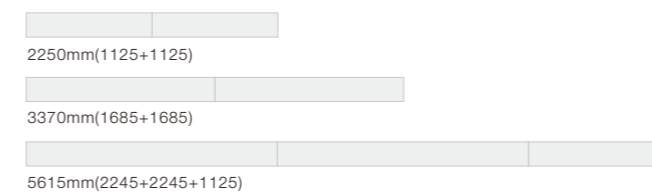

h(m)	Ea(lx)	E(max)	D(cm)
1	348.2	662.4	141.55
2	87.05	165.6	283.09
3	38.69	73.60	424.64
4	21.76	41.40	566.18
5	13.93	26.50	707.73

Beam Angle 110° 36W 4000K

## ORDERING INFORMATION:

**Example:** CXS75105G-36W/830/ND

Model	Wattage	CRI & CCT	Dimming
CXS75105G	36W	830	ND
CXS75105G	36W	830 Ra≥80 3000K	ND Non Dim
		840 Ra≥80 4000K	TD Triac Dim
		860 Ra≥80 6000K	VD 0/1-10V Dim
			DD DALL Dim

## Sinan

**CXS7545G**

**Wattage** : 30W  
**CRI** : Ra ≥ 80  
**CCT** : 3000K / 4000K / 6000K  
**Beam** : 110°  
**Lumen** : 2200lm  
**Finish** : BK / DW  
**Material** : Extruded aluminum body and PC

**Pendant wire:**  
**1.5 meters long as standard**

Pendant

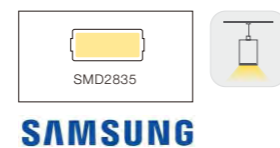
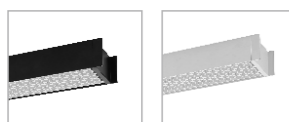
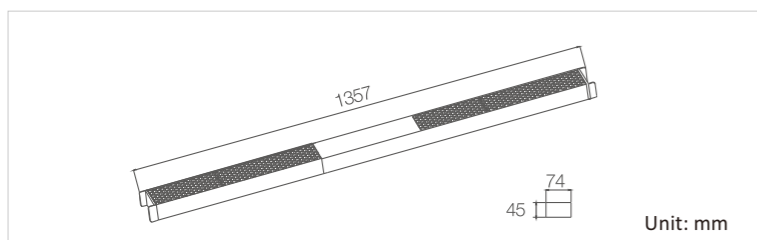

Linear connection can be achieved.

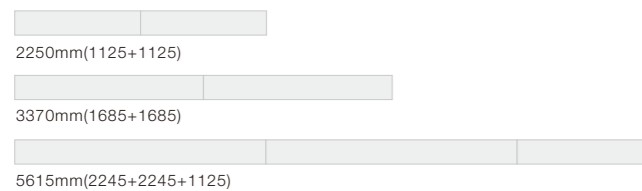

h(m)	E(max)	D(cm)
1	1191.78	147.45
2	297.95	294.91
3	132.42	442.36
4	74.49	589.81
5	33.11	884.72

Beam Angle 110° 30W

**ORDERING INFORMATION:**

**Example:** CXS7545G-30W/830/ND

Model	Wattage	CRI & CCT	Dimming
CXS7545G	30W	830	ND
CXS7545G	30W	830 Ra≥80 3000K	ND Non Dim
		840 Ra≥80 4000K	TD Triac Dim
		860 Ra≥80 6000K	VD 0/1-10V Dim
			DD DALL Dim

## Naples

**CEB3008T-D**

**Wattage** : 60W  
**CRI** : Ra ≥ 80  
**CCT** : 3000K / 4000K / 6000K  
**Beam** : 110°  
**Lumen** : 3500lm  
**Finish** : DW  
**Material** : Extruded aluminum body and PMMA Light guide Plate

Floor lamp

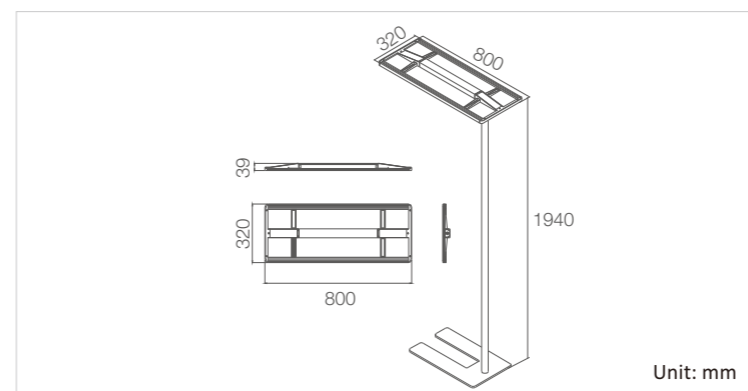

PIR sensor optional

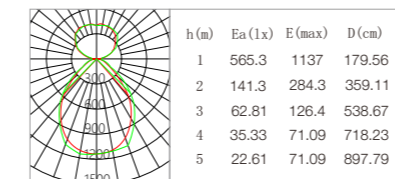

Beam Angle 110° 36W 4000K

**ORDERING INFORMATION:**

**Example:** CEB3008T/D/60W/830/ND

Model	Wattage	CRI & CCT	Dimming
CEB3008T/D	60W	830	ND
CEB3008T/D	60W	830 Ra≥80 3000K	ND Non Dim
		840 Ra≥80 4000K	TD Triac Dim
		860 Ra≥80 6000K	VD 0/1-10V Dim
			DD DALL Dim

